

TENTATIVE

**All information in this technical data sheet is tentative
and subject to change without notice.**

Eagle Touch Technologies Co.ltd
www.eagle-touch.com
Email: info@eagle-touch.com

5.0”WVGA

TECHNICAL SPECIFICATION

AA050MH01

MITSUBISHI ELECTRIC CORPORATION

Date: Jun. 1,'16

CONTENTS

No.	Item	Page
--	COVER	1
--	CONTENTS	2
1	APPLICATION	3
2	OVERVIEW	4
3	ABSOLUTE MAXIMUM RATINGS	5
4	ELECTRICAL CHARACTERISTICS	5, 6, 7
5	INTERFACE PIN CONNECTION	8
6	INTERFACE TIMING	9, 10, 11, 12
7	BLOCK DIAGRAM	13
8	MECHANICAL SPECIFICATION	14, 15
9	OPTICAL CHARACTERISTICS	16, 17, 18
10	RELIABILITY TEST CONDITION	19
11	OTHER FEATURE	20
12	HANDLING PRECAUTIONS FOR TFT-LCD MODULE	21, 22, 23

1. APPLICATION

This specification applies to color TFT-LCD module, AA050MH01.

These specification papers are the proprietary product of Mitsubishi Electric Corporation (“MITSUBISHI”) and include materials protected under copyright of MITSUBISHI. No part of this document may be reproduced in any form or by any means without the express written permission of MITSUBISHI.

MITSUBISHI does not assume any liability for infringement of patents, copyrights or other intellectual property rights of third parties by or arising from use of a product specified in this document. No license, express, implied or otherwise, is granted under any patents, copyrights or other intellectual property rights of MITSUBISHI or of others.

MITSUBISHI’s TFT-LCD module is designed and produced for “General Application” which is described as below.

<General Application>

Computers, office automation equipment, factory automation equipment, test and measurement equipment, communications, medical equipment which has no impact for human life and body, display equipment utilized in transportation system (automobiles, ships, trains, etc) which has no influence on its operation directly or indirectly.

Therefore, MITSUBISHI do not guarantee using our TFT-LCD for other application such as medical equipment, safety equipment, transportation system which might be influenced for its operation because of LCD-TFT, military systems, defense equipment, aerospace equipment, nuclear reactor control systems, and any other application in which there is a direct or indirect risk for human life and body or where high levels of reliability are required. Please confirm your application before using MITSUBISHI’s TFT-LCD.

Furthermore, it is mandatory to make contract (document base) by both parties (customer and MITSUBISHI), in case if customers intend to use our TFT-LCD for such application as military systems, defense equipment, aerospace equipment and nuclear reactor control systems, “which has significant impact for human life and body”. Otherwise, please do not use MITSUBISHI’s TFT-LCD for any cases.

MITSUBISHI has been making continuous effort to improve the reliability of its products. However customers should implement sufficient reliability design of their application equipments such as redundant system design, fail-safe functions and anti-failure features.

MITSUBISHI assumes no responsibility for any damage, including but not limited to damage to human life and body, resulting from the use of the product for the application other than the above mentioned General Application or the use of the product that does not comply with the instructions and the precautions specified in this document.

2. OVERVIEW

AA050MH01 is 5.0" color TFT-LCD (Thin Film Transistor Liquid Crystal Display) module composed of LCD panel, driver ICs, control circuit, and backlight unit.

By applying 8 bit digital data, 800 × 480, 16.7M-color images are displayed on the 5.0" diagonal screen. Input power voltage is 3.3 V for LCD driving.

The type of data and control signals are digital and transmitted via CMOS interface per Typ. 30.4 MHz clock cycle.

Driver circuit for LED backlight is not included in this module. General specifications are summarized in the following table:

ITEM	SPECIFICATION
Display Area (mm)	108.0(H) × 64.8(V) (5.0-inch diagonal)
Number of Dots	800 × 3 (H) × 480 (V)
Pixel Pitch (mm)	0.135(H) × 0.135 (V)
Color Pixel Arrangement	RGB vertical stripe
Display Mode	Normally black
Number of Color	16.7M(8 bit/color)
Luminance (cd/m ²)	500
Viewing Angle (CR ≥ 10)	-85~85° (H), -85~85° (V)
Surface Treatment	Clear and hard-coating 2H
Electrical Interface	CMOS
Module Size (mm)	118.5(W) × 77.8(H) × 3.9(D) *)
Module Mass (g)	76
Backlight Unit	Edge-light, LED

*) W/O FPC

Characteristic value without any note is typical value.

3. ABSOLUTE MAXIMUM RATINGS

ITEM	SYMBOL	MIN.	MAX.	UNIT
Power Supply Voltage for LCD	VCC	-0.3	4.0	V
Logic Input Voltage	VI	-0.3	VCC+0.3	V
Backlight (LED) Current	IF	--	30	mA
Operation Temperature <small>Note 1,2)</small>	T _{op}	-30	80	°C
Storage Temperature <small>Note 2)</small>	T _{stg}	-30	80	°C

[Note]

1) MIN.: Measured at the center of panel surface, MAX.: Measured at the center of panel back surface

2) Top, Tstg ≤ 40°C : 90%RH max. without condensation

Top, Tstg > 40°C : Absolute humidity shall be less than the value of 90%RH at 40°C without condensation.

4. ELECTRICAL CHARACTERISTICS

(1) TFT- LCD

Ambient temperature: Ta = 25°C

ITEM	SYMBOL	MIN.	TYP.	MAX.	UNIT	Remarks
Power Supply Voltage for LCD	VCC	3.0	3.3	3.6	V	*1)
Power Supply Current for LCD	ICC	--	140	280	mA	*2)
Permissive Input Ripple Voltage	VRP	--	--	100	mVp-p	VCC = +3.3V
Logic Input Voltage	High	VIH	2.0	--	VCC	V
	Low	VIL	0	--	0.8	V

*1) Power and signals sequence:

$$\begin{aligned}
 0.1 \text{ ms} \leq t_1 \leq 10 \text{ ms} & \quad 200 \text{ ms} \leq t_4 \\
 0 < t_2 \leq 50 \text{ ms} & \quad 200 \text{ ms} \leq t_5 \\
 0 < t_3 \leq 50 \text{ ms} & \quad 0 \leq t_6
 \end{aligned}$$

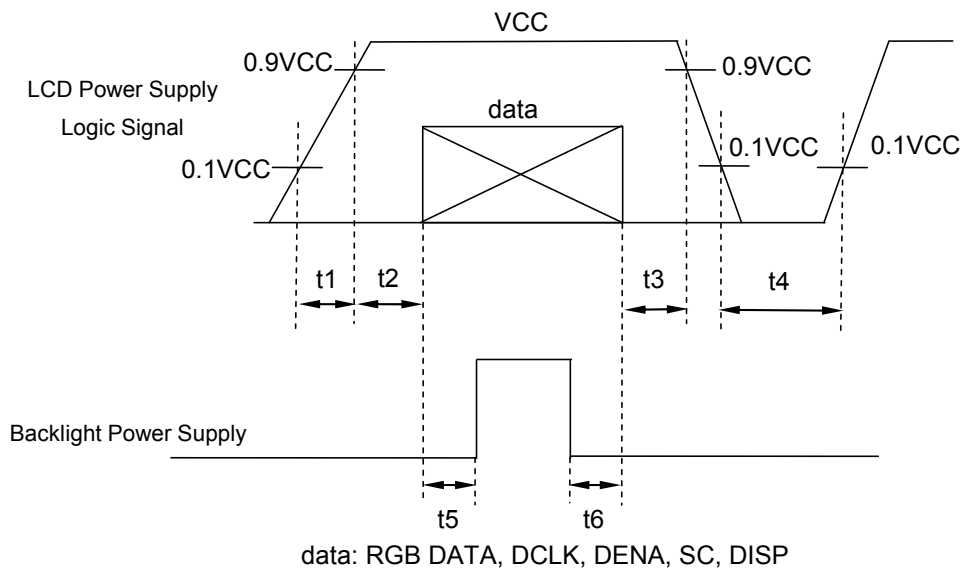

VCC-dip conditions:

When $VCC < 2.4V$ or $VCC < 3.0V$ and $10ms < t_d$, this product may not work normally.
Please reset power supply according to the power and signals sequence (see 4.(1)*1)).

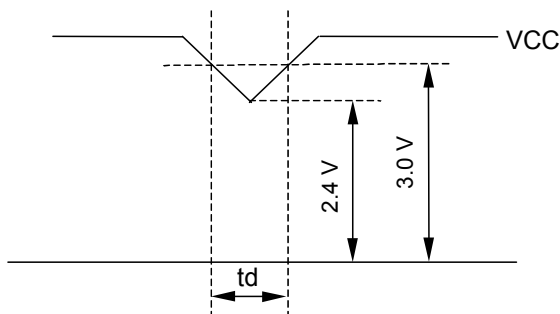

*2) $VCC = + 3.3 V$, $f_H=31.6kHz$, $f_V=60Hz$, $f_{CLK}= 30.4MHz$

Display image at typical power supply current value is 256-gray-bar pattern (8 bit), 480 line mode.

*3) Fuse

Parameter	Fuse Type Name	Supplier	Remark
VCC	FCC16102AB	Kamaya Electric Co., Ltd.	*)

*) The power supply capacity should be designed to be more than the fusing current.

(2) Backlight

ITEM	SYMBOL	MIN.	TYP.	MAX.	UNIT	Remarks
LED Voltage	VF	--	(24.0)	28.4	V	IF = 20 mA, Ta = 25°C, *2)
		--	--	29.4	V	IF = 20 mA, Ta = 0°C
		--	--	30.6	V	IF = 20 mA, Ta = -30°C
LED Current	IF	--	20.0	25.0	mA	Ta = 25°C, *1), *3)

[Note]

*1) Constant Current Drive

*2) The Voltage deviation between strings: $|V_{f1} - V_{f2}| \leq 2V$

*3) LED Current measurement method

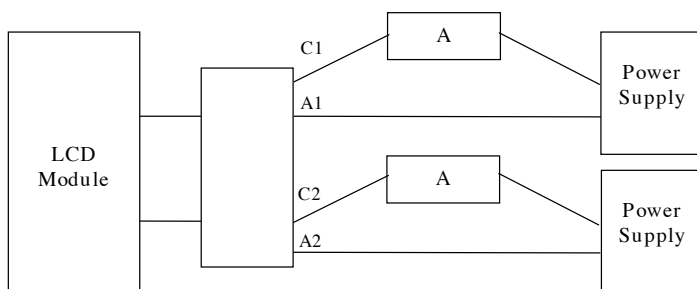

Diode IF-Ta CHARACTERISTICS DIAGRAM

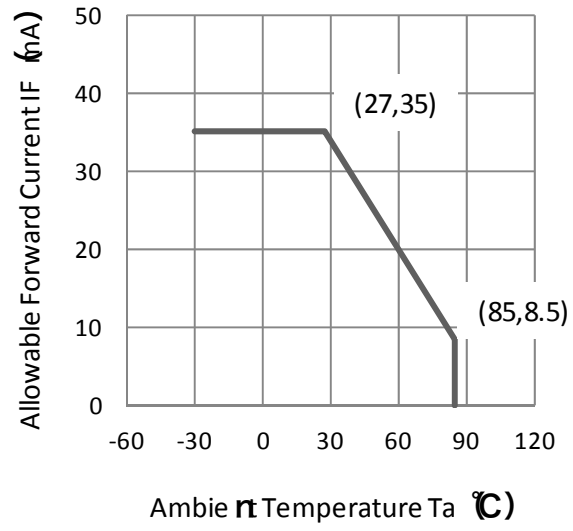

5. INTERFACE PIN CONNECTION

FPC1 (Interface Signal)

Pin No.	Symbol	Function
1	GND	
2	GND	
3	VCC	3.3 V Power Supply
4	VCC	3.3 V Power Supply
5	R0	Red data signal(LSB)
6	R1	Red data signal
7	R2	Red data signal
8	R3	Red data signal
9	R4	Red data signal
10	R5	Red data signal
11	R6	Red data signal
12	R7	Red data signal(MSB)
13	G0	Green data signal(LSB)
14	G1	Green data signal
15	G2	Green data signal
16	G3	Green data signal
17	G4	Green data signal
18	G5	Green data signal
19	G6	Green data signal
20	G7	Green data signal(MSB)
21	B0	Blue data signal(LSB)
22	B1	Blue data signal
23	B2	Blue data signal
24	B3	Blue data signal
25	B4	Blue data signal
26	B5	Blue data signal
27	B6	Blue data signal
28	B7	Blue data signal(MSB)
29	GND	
30	DCLK	Clock signal for sampling catch data signal
31	DISP	Display on/off (Low: off, High: on)
32	HD	Horizontal sync signal *1)
33	VD	Vertical sync signal *1)
34	DENA	Data enable signal (to settle the viewing area)
35	NC	This pin should be open.
36	SC	Scan direction control (Low= Normal, High= Reverse)
37	GND	
38	LED_C1	LED cathode 1
39	LED_A1	LED anode 1
40	LED_C2	LED cathode 2
41	LED_A2	LED anode 2
42	NC	This pin should be open.
43	NC	This pin should be open.
44	NC	This pin should be open.
45	NC	This pin should be open.

*1) HD and VD are not being used for timing control.

*2) Metal frame is connected to signal GND.

6. INTERFACE TIMING

(1) Timing Specifications

ITEM		SYMBOL	MIN.	TYP.	MAX.	UNIT	
DCLK	Frequency	f _{CLK}	--	30.4	45	MHz	
	Period	t _{CLK}	22.2	32.9	--	ns	
	Low Width	t _{WCL}	10	--	--	ns	
	High Width	t _{WCH}	10	--	--	ns	
DATA(R,G,B), DENA	Set up time	t _{DS}	6	--	--	ns	
	Hold time	t _{DH}	4	--	--	ns	
DENA	Horizontal	Active Time	t _{HA}	800	800	800	t _{CLK}
		Blanking Time	t _{HB}	20	160	--	t _{CLK}
		Frequency	f _H	--	31.6	45	kHz
		Period	t _H	22.2	31.7	--	μs
	Vertical	Active Time	t _{VA}	480	480	480	t _H
		Blanking Time	t _{VB}	4	45	--	t _H
		Frequency	f _V	55	60	75	Hz
		Period	t _V	13.3	16.7	18.2	ms

[Note]

- 1) DATA is latched at fall edge of DCLK in this specification.
- 2) DENA (Data Enable) should always be positive polarity as shown in the timing specification.
- 3) DCLK should appear during all invalid period.
- 4) In case of blanking time fluctuation, please satisfy following condition.

$$t_{VBn} > t_{VBn-1} - 3(t_H)$$

(2) Timing Chart

a. Pixel Timing Chart

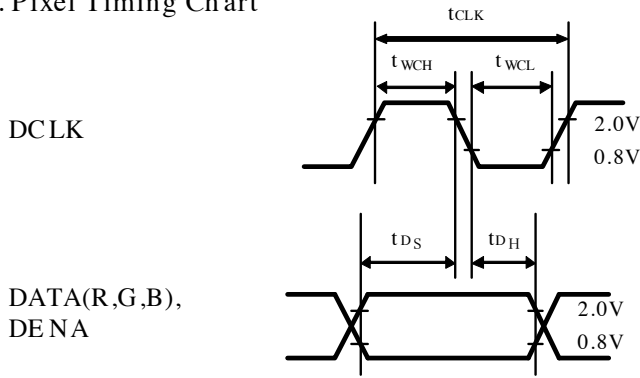

b. Horizontal Timing Chart

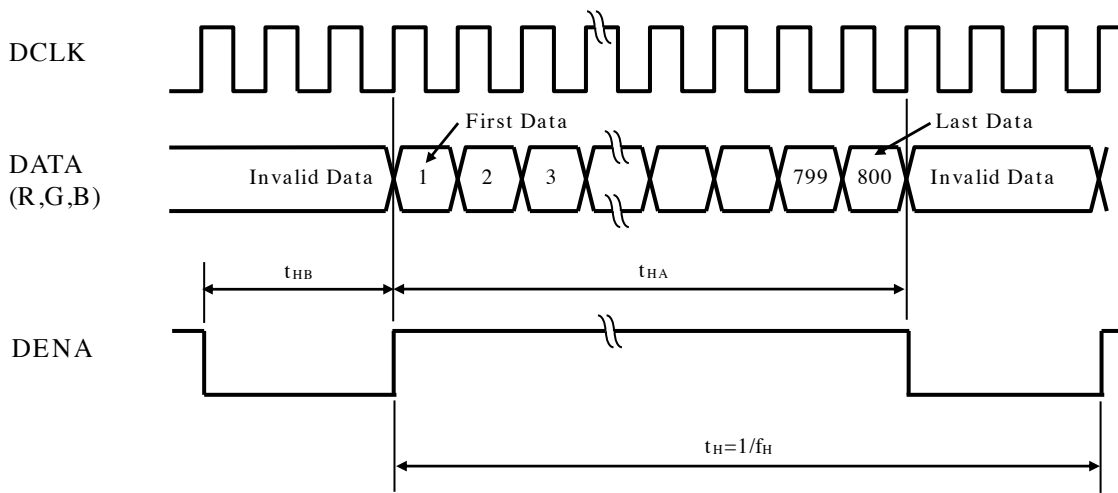

c. Vertical Timing Chart

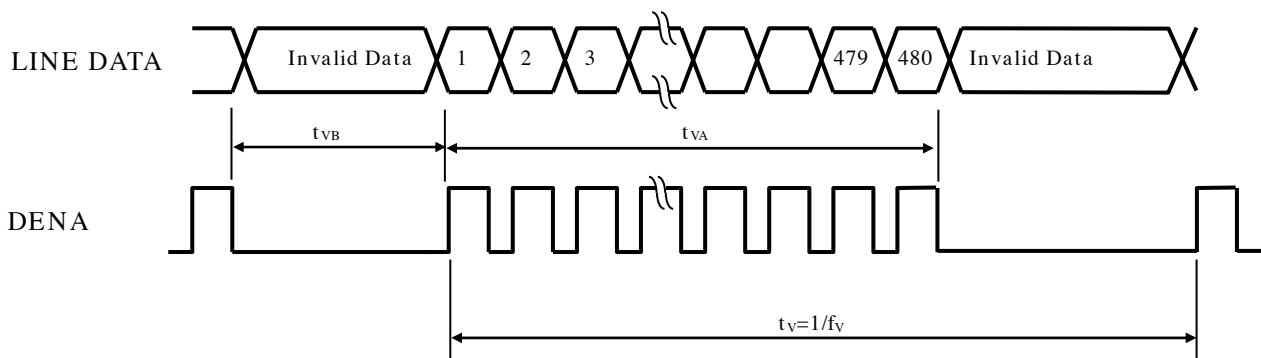

(3) Color Data Assignment

COLOR		INPUT DATA																													
		R DATA								G DATA								B DATA													
		R7	R6	R5	R4	R3	R2	R1	R0	G7	G6	G5	G4	G3	G2	G1	G0	B7	B6	B5	B4	B3	B2	B1	B0						
		MSB								LSB								MSB								LSB					
BASIC COLOR	BLACK	0	0	0	0	0	0	0	0	0	0	0	0	0	0	0	0	0	0	0	0	0	0	0	0						
	RED(255)	1	1	1	1	1	1	1	1	0	0	0	0	0	0	0	0	0	0	0	0	0	0	0	0						
	GREEN(255)	0	0	0	0	0	0	0	0	1	1	1	1	1	1	1	1	0	0	0	0	0	0	0	0						
	BLUE(255)	0	0	0	0	0	0	0	0	0	0	0	0	0	0	0	0	1	1	1	1	1	1	1	1						
	CYAN	0	0	0	0	0	0	0	0	1	1	1	1	1	1	1	1	1	1	1	1	1	1	1	1						
	MAGENTA	1	1	1	1	1	1	1	1	0	0	0	0	0	0	0	0	1	1	1	1	1	1	1	1						
	YELLOW	1	1	1	1	1	1	1	1	1	1	1	1	1	1	1	1	0	0	0	0	0	0	0	0						
	WHITE	1	1	1	1	1	1	1	1	1	1	1	1	1	1	1	1	1	1	1	1	1	1	1	1						
RED	RED(1)	0	0	0	0	0	0	0	1	0	0	0	0	0	0	0	0	0	0	0	0	0	0	0	0						
	RED(2)	0	0	0	0	0	0	1	0	0	0	0	0	0	0	0	0	0	0	0	0	0	0	0	0						
	RED(255)	1	1	1	1	1	1	1	1	0	0	0	0	0	0	0	0	0	0	0	0	0	0	0	0						
GREEN	GREEN(1)	0	0	0	0	0	0	0	0	0	0	0	0	0	0	0	1	0	0	0	0	0	0	0	0						
	GREEN(2)	0	0	0	0	0	0	0	0	0	0	0	0	0	0	1	0	0	0	0	0	0	0	0	0						
	GREEN(255)	0	0	0	0	0	0	0	0	1	1	1	1	1	1	1	1	0	0	0	0	0	0	0	0						
BLUE	BLUE(1)	0	0	0	0	0	0	0	0	0	0	0	0	0	0	0	0	0	0	0	0	0	0	0	1						
	BLUE(2)	0	0	0	0	0	0	0	0	0	0	0	0	0	0	0	0	0	0	0	0	0	0	1	0						
	BLUE(255)	0	0	0	0	0	0	0	0	0	0	0	0	0	0	0	0	1	1	1	1	1	1	1	1						

[Note]

1) Definition of gray scale

Color (n) ---n indicates gray scale level.

Higher n means brighter level.

2) Data

1:High, 0: Low

(4) Display Position and Scan Direction

D(X,Y) shows the data number of input signal.

SC: Low

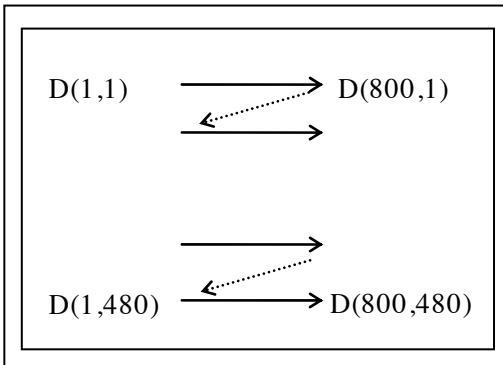

SC: High

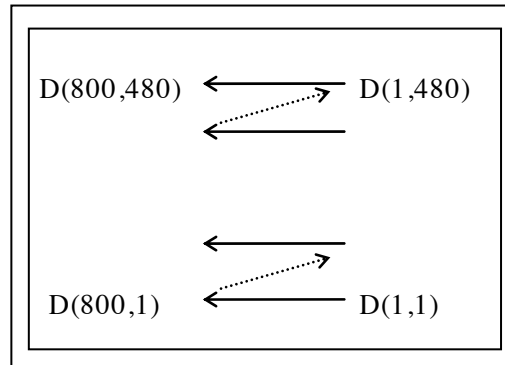

7. BLOCK DIAGRAM

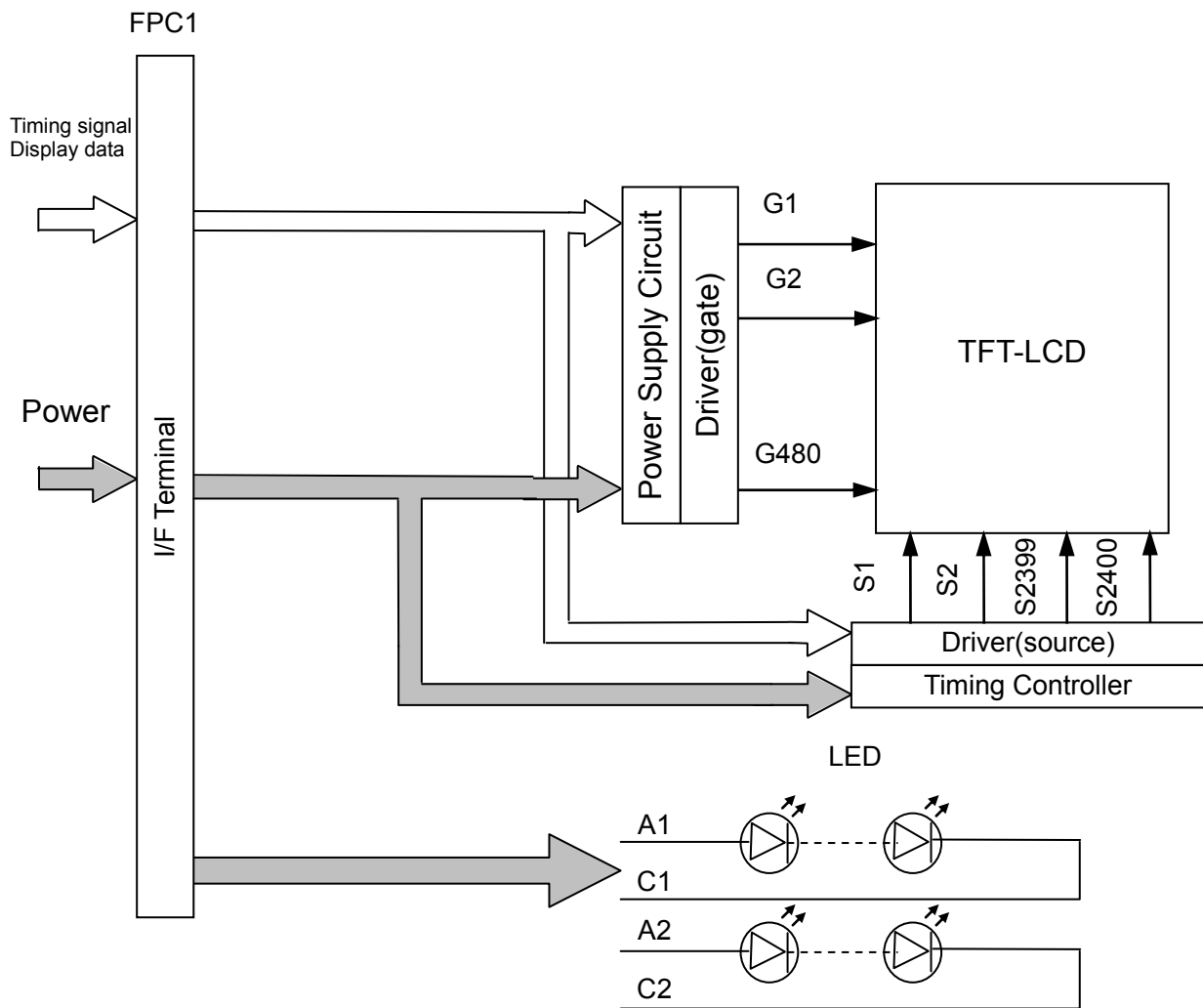

8. MECHANICAL SPECIFICATIONS

(1) Outline Dimensions

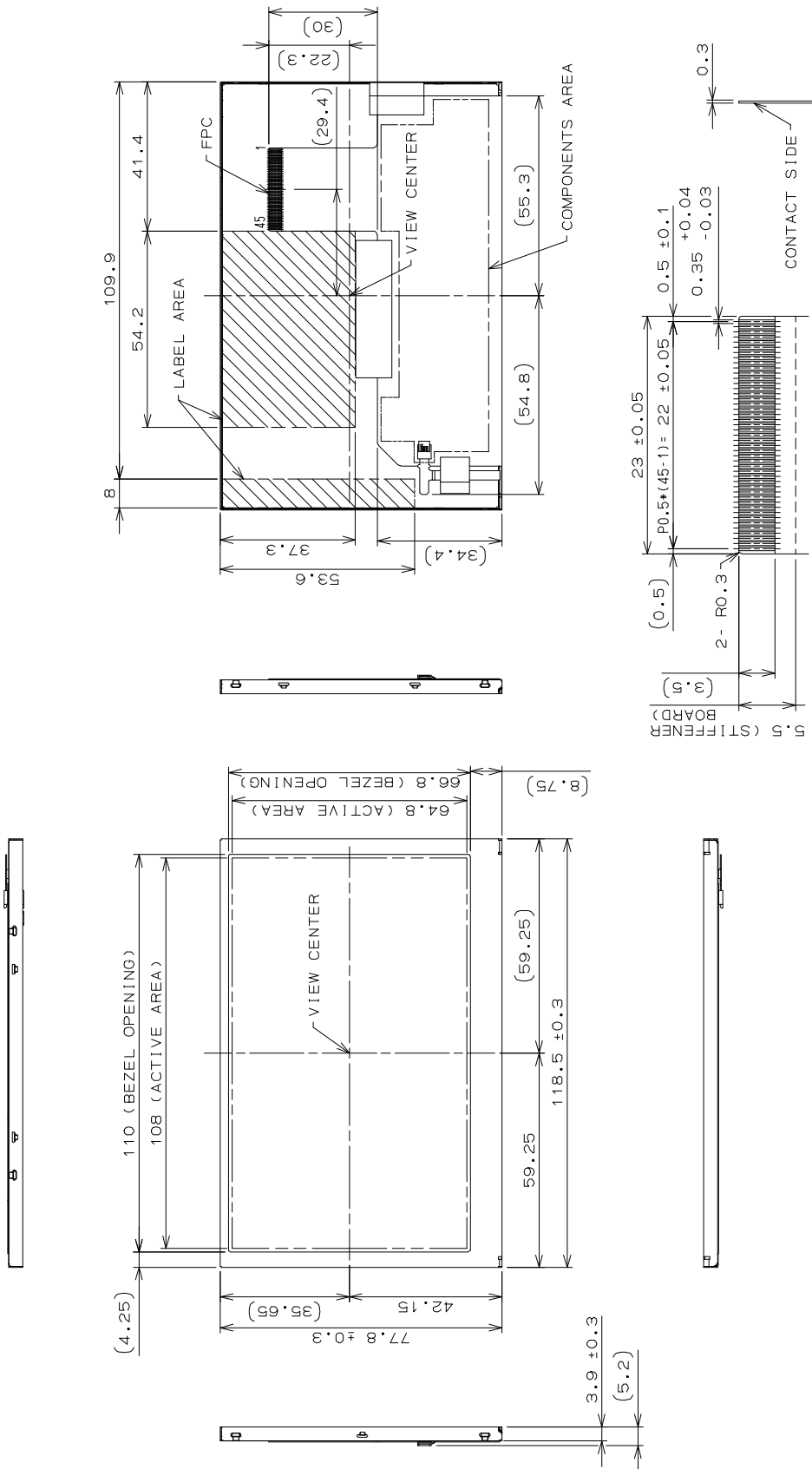

AA050MH01

- 1) Tolerance is ±0.5mm unless noted.
- 2) Third angle projection

(Unit:mm)

(2) Recommended Holding Area

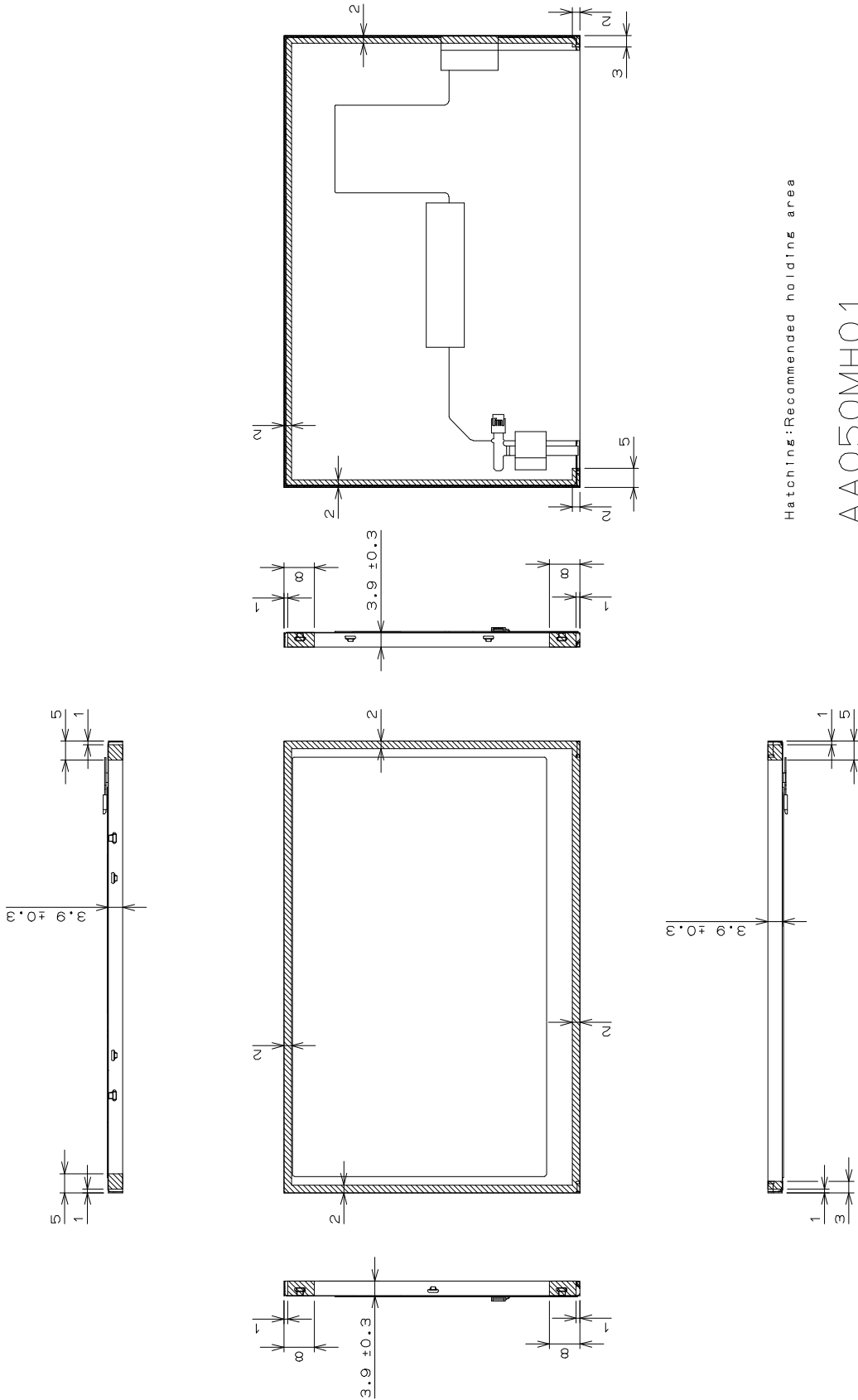

Hatching: Recommended holding area

AA050MH01

- 1) Tolerance is ± 0.5 mm unless noted.
- 2) Third angle projection

(Unit:mm)

9. OPTICAL CHARACTERISTICS

Ta=25°C, VCC=3.3V, Input Signals: Typ. values shown in Section 6

ITEM		SYMBOL	CONDITION	MIN.	TYP.	MAX.	UNIT	Remarks
Contrast Ratio		CR	$\theta_V=0^\circ, \theta_H=0^\circ$	650	1000	--	--	*1)*2)*5)
Luminance		L _w	$\theta_V=0^\circ, \theta_H=0^\circ$	400	500	--	cd/m ²	*1)*5)
Luminance Uniformity		ΔL_w	$\theta_V=0^\circ, \theta_H=0^\circ$	--	--	30	%	*1)*3)*5)
Response Time		t _r	$\theta_V=0^\circ, \theta_H=0^\circ$	--	12	--	ms	*1)*4)*5)
		t _f	$\theta_V=0^\circ, \theta_H=0^\circ$	--	12	--	ms	*1)*4)*5)
Viewing Angle	Horizontal	θ_H	CR ≥ 10	-70~70	-85~85	--	°	*1)*5)
	Vertical	θ_V		-70~70	-85~85	--	°	*1)*5)
Image Sticking		t _{is}	2 h	--	--	2	s	*6)
Color Coordinates	Red	R _x	$\theta_V=0^\circ, \theta_H=0^\circ$	0.525	0.575	0.625	--	*1)*5)
		R _y		0.265	0.315	0.365		
	Green	G _x		0.287	0.337	0.387		
		G _y		0.534	0.584	0.634		
	Blue	B _x		0.100	0.150	0.200		
		B _y		0.073	0.123	0.173		
	White	W _x		0.263	0.313	0.363		
		W _y		0.279	0.329	0.379		

[Note]

These items are measured using EZContrast XL88F(ELDIM) for viewing angle, RD-80SA(TOPCON) for response time and CS-2000 (KONICA MINOLTA) or equivalent equipment for others under the dark room condition (no ambient light) after more than 30 minutes from turning on the backlight unless noted.

Condition: IF = 20 mA

Measurement method for luminance and color coordinates is as follows.

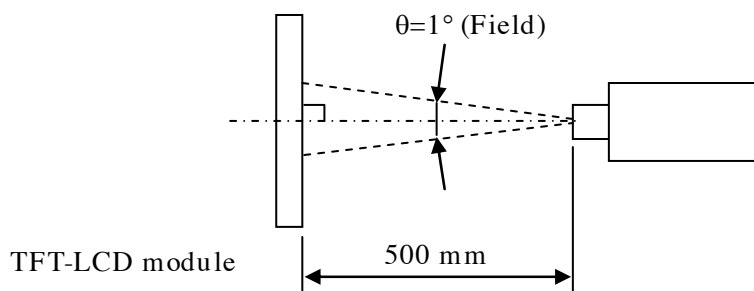

The luminance is measured according to FLAT PANEL DISPLAY MEASUREMENTS STANDARD (VESA Standard).

*1) Measurement Point

Contrast Ratio, Luminance, Response Time, Viewing Angle, Color Coordinates: Display Center
 Luminance Uniformity: point 1~5 shown in a figure below

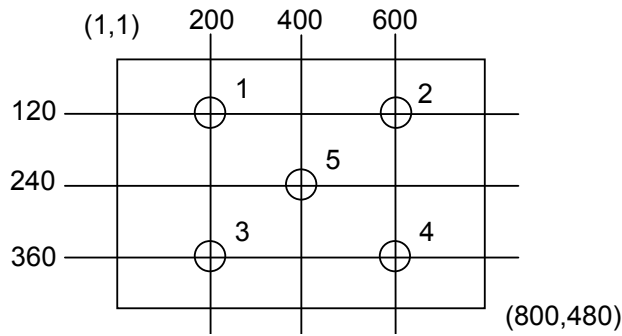

*2) Definition of Contrast Ratio

$CR = \text{Luminance with all white pixels} / \text{Luminance with all black pixels}$

*3) Definition of Luminance Uniformity

$\Delta Lw = [Lw(\text{MAX}) / Lw(\text{MIN}) - 1] \times 100$

*4) Definition of Response Time

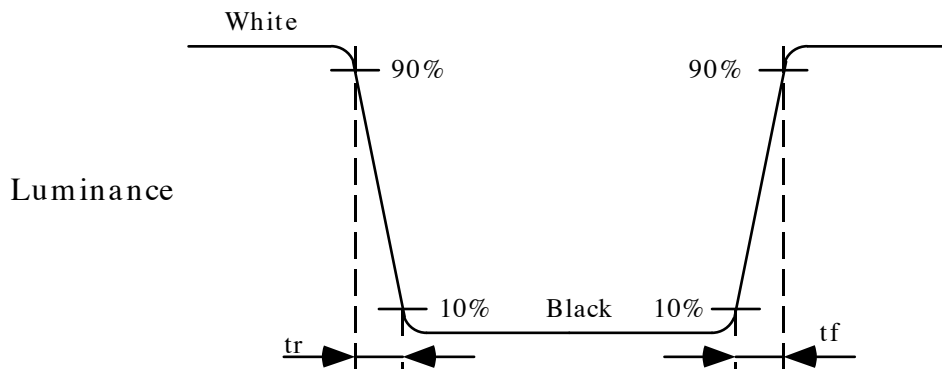

*5) Definition of Viewing Angle (θ_v , θ_H)

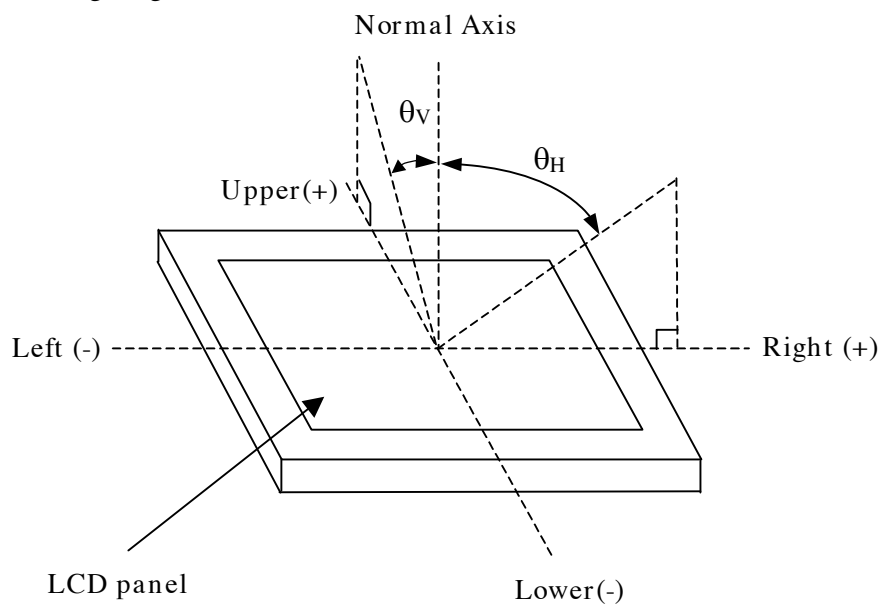

*6) Image Sticking

Continuously display the test pattern shown in the figure below for two-hours. Then display a completely white screen. The previous image shall not persist more than two seconds at 25°C.

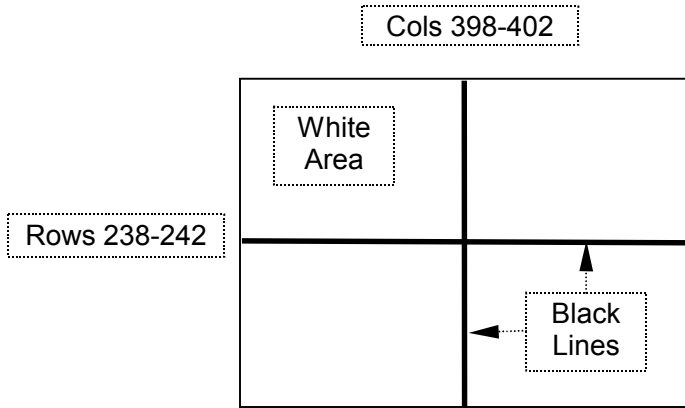

TEST PATTERN FOR IMAGE STICKING TEST

10. RELIABILITY TEST CONDITION

(1) Temperature and Humidity

ITEM	CONDITIONS
HIGH TEMPERATURE HIGH HUMIDITY OPERATION	40°C, 90%RH, 240 h (No condensation)
HIGH TEMPERATURE OPERATION	80°C, 240 h
LOW TEMPERATURE OPERATION	-30°C, 240 h
HIGH TEMPERATURE STORAGE	80°C, 240 h
LOW TEMPERATURE STORAGE	-30°C, 240 h
THERMAL SHOCK (NON-OPERATION)	-30°C (1h) ~ 80°C(1h), 100 cycles

(2) Shock & Vibration

ITEM	CONDITIONS
SHOCK (NON-OPERATION)	Shock level: 1470m/s ² (150G) Waveform: half sinusoidal wave, 2ms Number of shocks: one shock input in each direction of three mutually perpendicular axis for a total of six shock inputs
VIBRATION (NON-OPERATION)	Vibration level: 9.8m/s ² (1.0G) Waveform: sinusoidal Frequency range: 5 to 500Hz Frequency sweep rate: 0.5 octave /min Duration: one sweep from 5 to 500 Hz in each of three mutually perpendicular axis(each x,y,z axis: 1 hour, total 3 hours)

(3) ESD Test

ITEM	CONDITIONS
CONTACT DISCHARGE (OPERATION)	150pF, 330Ω, ±8kV, 10 times at 1 sec interval
SIGNAL PIN DISCHARGE (NON-OPERATION)	200pF, 0Ω, ±200V, 10 times at 1 sec interval

(4) Judgment standard

The judgment of the above tests should be made as follow:

Pass: Normal display image, no damage of the display function. (ex. no line defect)

Partial transformation of the module parts should be ignored.

Fail: No display image, damage of the display function. (ex. line defect)

11. OTHER FEATURE

(1) Environmental Restriction /Law Compliance

This LCD module complies with RoHS*) directive.

*) RoHS: Restriction of the use of certain hazardous substances in electrical and electronic equipment

(2) Safety Standard Authorization

UL1950 Recognized (UL File# E158720)

(3) Warranty Period

26 months after shipment from our factory

12. HANDLING PRECAUTIONS FOR TFT-LCD MODULE

Please pay attention to the followings in handling TFT-LCD products;

(1) ASSEMBLY PRECAUTION

- a. Please do not bend or wrench the LCD module in assembling. Please do not drop, bend or twist the LCD module in handling.
- b. Please design display housing in accordance with the following guide lines.
 - (a) Housing case must be designed carefully so as not to put stresses on LCD and not to wrench module.
 - (b) Under high temperature environment, performance and life time of LED may heavily shorten. When you design with our LCD product, please consider radiating heat and ventilation for good heat management.
 - (c) Keep sufficient clearance between LCD module back surface and housing when the LCD module is mounted. Approximately 1.0mm of the clearance in the design is recommended taking into account the tolerance of LCD module thickness and mounting structure height on the housing.
 - (d) When some parts, such as, FPC cable and ferrite plate, are installed underneath the LCD module, still sufficient clearance is required, such as 0.5mm. This clearance is, especially, to be reconsidered when the additional parts are implemented for EMI countermeasure.
 - (e) Design the LED driver location and connector position carefully so as not to give stress to LED backlight cable.
 - (f) Keep sufficient clearance between LCD module and the others parts, such as inverter and speaker so as not to interfere the LCD module. Approximately 1.0 mm of the clearance in the design is recommended.
 - (g) To avoid local elevation/decrease of temperature, considering location of heating element, heat release, thermal design should be done.
- c. Please do not push or scratch LCD panel surface with anything hard. And do not soil LCD panel surface by touching with bare hands. (Polarizer film, surface of LCD panel is easy to be flawed.)
- d. Do not use or store the product under a condition where the product will be exposed to water, organic solution or acid.
- e. Please wipe off LCD panel surface with absorbent cotton or soft cloth in case of it being soiled.
- f. Please wipe off drops of adhesives like saliva and water on LCD panel surface immediately. They might damage to cause panel surface variation and color change.
- g. Please do not take a LCD module to pieces and reconstruct it. Resolving and reconstructing modules may cause them not to work well.
- h. Please do not touch metal frames with bare hands and soiled gloves. A color change of the metal frames can happen during a long preservation of soiled LCD modules.
- i. Please handle metal frame carefully because edge of metal frame is very sharp.

- j. Please connect the metal frame of LCD module to GND in order to minimize the effect of external noise and EMI.
- k. Be sure to connect the cables and the connectors correctly.

(2) OPERATING PRECAUTIONS

- a. Please be sure to turn off the power supply before connecting and disconnecting signal input cable.
- b. Please do not change variable resistance settings in LCD module. They are adjusted to the most suitable value. If they are changed, it might happen LCD does not satisfy the characteristics specification.
- c. The interface signal speed is very high. Please pay attention to transmission line design and other high speed signal precautions to satisfy signal specification.
- d. Condensation might happen on the surface and inside of LCD module in case of sudden change of ambient temperature. Please take care so as not to cause any damage mentioned on (1)-d.
- e. Please pay attention not to display the same pattern for very long time. Image sticking might happen on LCD. Although image sticking may disappear as the operation time proceeds, screen saver function is recommended not to cause image sticking.
- f. Please obey the same safe instructions as ones being prepared for ordinary electronic products.

(3) PRECAUTIONS WITH ELECTROSTATICS

- a. This LCD module use CMOS-IC on circuit board and TFT-LCD panel, and so it is easy to be affected by electrostatics. Please be careful with electrostatics by the way of your body connecting to the ground and so on.
- b. Please remove protection film very slowly from the surface of LCD module to prevent from electrostatics occurrence.

(4) STORAGE PRECAUTIONS

LCD should be stored in the room temperature environment with normal humidity. The LCD inventory should be processed by first-in first-out method.

(5) SAFETY PRECAUTIONS

- a. When you waste damaged or unnecessary LCDs, it is recommended to crush LCDs into pieces and wash them off with solvents such as acetone and ethanol, which should later be burned.
- b. If any liquid leaks out of a damaged glass cell and comes in contact with the hands, wash off thoroughly with soap and water.
- c. Be sure to turn off the power supply when inserting or disconnecting the LED backlight cable.

- d. LED driver should be designed carefully to limit or stop its function when over current is detected on the LED.

(6) OTHERS

- a. A strong incident light into LCD panel may cause deterioration to polarizer film, color filter, and other materials, which will degrade the quality of display characteristics. Please do not expose LCD module under strong Ultraviolet rays for a long time.
- b. Please pay attention to a panel side of LCD module not to contact with other materials in preserving it alone.
- c. For the packaging box handling, please see and obey with the packaging specification datasheet.