

SHARP

No.	LCY-W-14567C
DATE	Feb. 16th. 2015

TECHNICAL LITERATURE
FOR
TFT - LCD module

MODEL No. LQ080Y3LW01

The technical literature is subject to change with notice.
Please contact Sharp or its representative before designing your
product based on this literature.

DISPLAY DEVICE BUSINESS GROUP

SHARP CORPORATION



Copyright © 2015 SHARP All rights reserved.

NOTICE

This publication is the proprietary of SHARP and is copyrighted, with all rights reserved. Under the copyright laws, no part of this publication may be reproduced or transmitted in any form or by any means, electronic or mechanical for any purpose, in whole or in part, without the express written permission of SHARP. Express written permission is also required before any use of this publication may be made by a third party.

The application circuit examples in this publication are provided to explain the representative applications of SHARP's devices and are not intended to guarantee any circuit design or permit any industrial property right or other rights to be executed. SHARP takes no responsibility for any problems related to any industrial property right or a third party resulting from the use of SHARP's devices, except for those resulting directly from device manufacturing processes.

In the absence of confirmation by device specification sheets, SHARP takes no responsibility for any defects that occur in equipment using any of SHARP's devices, shown in catalogs, data books, etc. Contact SHARP in order to obtain the latest device specification sheets before using any SHARP's device.

Observe the following points when using any device in this publication. SHARP takes no responsibility for damage caused by improper use of the devices.

The devices in this publication are designed for use in general electronic equipment designs, such as:

Display Monitor equipments (Audio visual equipment, Car navigation system etc.)

The appropriate design measures should be taken to ensure reliability and safety when SHARP's devices are used for equipment such as:

- Transportation control and safety equipment (i.e., aircraft, trains, automobiles, etc.)
- Traffic signals • Gas leakage sensor breakers
- Alarm equipment • Various safety devices etc.

SHARP's devices shall not be used for equipment that requires extremely high level of reliability, such as:

- Military and space applications • Nuclear power control equipment
- Medical equipment for life support

Contact a SHARP representative, in advance, when intending to use SHARP's devices for any "specific" applications other than those recommended by SHARP.

Contact and consult with a SHARP representative if there are any questions about the contents of this publication.

TFT-LCD MODULE

LQ080Y3LW01

SPECIFICATION

CONTENTS

1. Applicable TFT-LCD module	p4
2. Summary and Features	p4
3. Construction and Outline	p4
4. Mechanical specifications	p4
5. Input terminal	p5
5-1. TFT-LCD panel driving	p5
5-2. LVDS Interface block diagram	p7
5-3. Data mapping	p8
5-4. Backlight driving	p9
6. Absolute maximum ratings	p10
7. Electrical characteristics	p11
7-1. TFT-LCD panel driving	p11
7-2. Power ON sequence	p12
7-3. Power OFF sequence	p13
7-4. Backlight driving section	p13
7-5. AC Characteristics (Input LVDS)	p14
8. Timing characteristics	p15
9. Input Data Signals and Display Position on the screen	p17
10. Input Signals, Basic Display Color and Grey Scale of Each Color	p18
11. Optical characteristics	p19
12. Display quality	p21
13. Mechanic characteristics	p21
13-1 External appearance	p21
13-2 Panel: Surface Compression Strength	p21
13-3 Input connector performance	p21
14. Handling instructions	p21
14-1 Handling of LED-FPC	p21
14-2 Precautions in mounting	p21
14-3 Caution of product design	p22
14-4. Others	p23
15. Packing form	p23
16. Indication of lot number	p23

17. Others	p24
17-1 Fab locations	p24
17-2 About RoHS	p24
17-3 Disposal of module	p24
18. Reliability test condition	p25
19. Outline Dimensions	p26
20. Packing form	p27

SHARP Confidential
Eagle Touch Technologies Co.Ltd
www.eagle-touch.com

1. Application

The SHARP Color TFT-LCD module is an active matrix LCD (Liquid Crystal Display) produced by making the most of Sharp's expertise in liquid-crystal and semiconductor technologies. The active device is amorphous silicon TFT (Thin Film Transistor).

2. Summary and Features

- Utilizes a panel with a 15:9 aspect ratio, which makes the module suitable for use in wide-screen systems.
- The 8 screen produces a high resolution image that is composed of 384,000 pixels elements in a stripe arrangement.
- Graphics and texts can be displayed on a 800×RGB×480 dots panel with 16,777,216 colors by supplying 24 bit data signals(8 bit/color).
- By adopting an active matrix drive, a picture with high contrast is realized.
- Reduced reflection as a result of low reflection black matrix and an antiglare (AG) polarizer being adopted.
- By COG method, realized a slim, lightweight, and compact module.
- Through the use of ASV –normally black mode, an image with highly natural color reproduction is realized.
- The backlight is excellent of brightness rising characteristics at low temperature.
- An inverted video display in the vertical and horizontal directions is possible.

3. Construction and Outline

The module consists of a TFT-LCD panel, drivers, FPC, PWB, backlight unit.

4. Mechanical specifications

Table 4-1

Parameter	Specifications	Units	Remarks
Screen size (Diagonal)	20.29 [7.99"]	cm	
Active area	174.0 (W) × 104.4 (H)	mm	
Display format	384,000	pixels	
	800 × RGB × 480	dots	
Dot pitch	0.0725(H) × 0.2175 (V)	mm	
Pixel configuration	R,G,B stripe configuration		
Display mode	Normally black		
Outline dimension	191.8 (W) × 120.7(H) × (7.25)(D)	mm	[Note4-1]
Mass	280MAX	g	

[Note4-1] Excluding protrusions. Typical values are given.



5. Input terminal

5-1. TFT-LCD panel driving

I/F CN

Used connector: (FH52-32S-0.5SH (05) [HIROSE])

Pin No.	Symbol	Function	Remarks
1	GND	Ground	
2	GND	Ground	
3	GND	Ground	
4	DATA3P	LVDS input data signal(Positive)	LVDS signal
5	DATA3N	LVDS input data signal(Negative)	LVDS signal
6	GND	Ground	
7	DATA2P	LVDS input data signal(Positive)	LVDS signal
8	DATA2N	LVDS input data signal(Negative)	LVDS signal
9	GND	Ground	
10	CLKP	LVDS input clock signal(Positive)	LVDS signal
11	CLKN	LVDS input clock signal(Negative)	LVDS signal
12	GND	Ground	
13	DATA1P	LVDS input data signal(Positive)	LVDS signal
14	DATA1N	LVDS input data signal(Negative)	LVDS signal
15	GND	Ground	
16	DATA0P	LVDS input data signal(Positive)	LVDS signal
17	DATA0N	LVDS input data signal(Negative)	LVDS signal
18	GND	Ground	
19	SHUT	Control signal for power supply	
20	GND	Ground	
21	NC	Non-connection	
22	VCC	Power supply for LCD module (Typ. +3.3V)	
23	VCC	Power supply for LCD module (Typ. +3.3V)	
24	VCC	Power supply for LCD module (Typ. +3.3V)	
25	VCC	Power supply for LCD module (Typ. +3.3V)	
26	NC	Non-connection	
27	GND	Ground	
28	GND	Ground	
29	LRSEL	Horizontal scanning direction switching signal	[Note5-1]
30	TBSEL	Vertical scanning direction switching signal	[Note5-1]
31	GND	Ground	
32	GND	Ground	

*To obtain the proper relation between LVDS signals and actual digital data signals, the digital signals should be inputted into the transmitter as described in the next section, 5-2.

*The shielding case is connected with signal GND.



[Note 5-1]

LRSEL: Selects the output shift direction of the source driver.

When LRSEL = "1", Right shifts to Left. When LRSEL = "0", Left shifts to Right.

TBSEL: Selects the output shift direction of the gate driver.

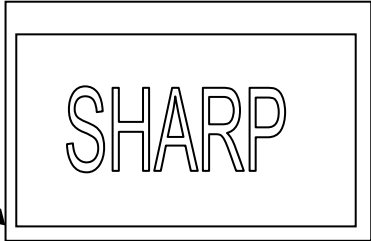
When TBSEL = "1", Top shifts to Bottom. When TBSEL = "0", Bottom shifts to Top.

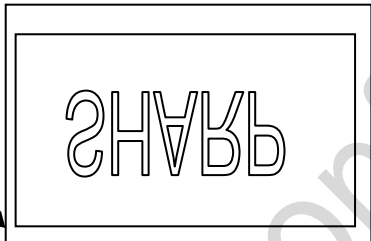
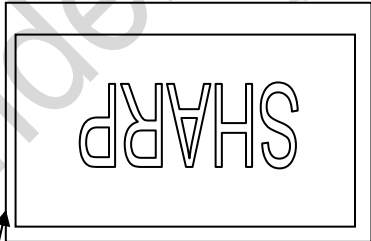
	LRSEL = "0"	LRSEL = "1"
TBSEL = "1"	 <p>LED FPC</p>	 <p>LED FPC</p>
TBSEL = "0"	 <p>LED FPC</p>	 <p>LED FPC</p>

5-2. LVDS Interface block diagram

Corresponding Transmitter : DS90CR285 (National Semiconductor)
 or compatible with DS90CR285

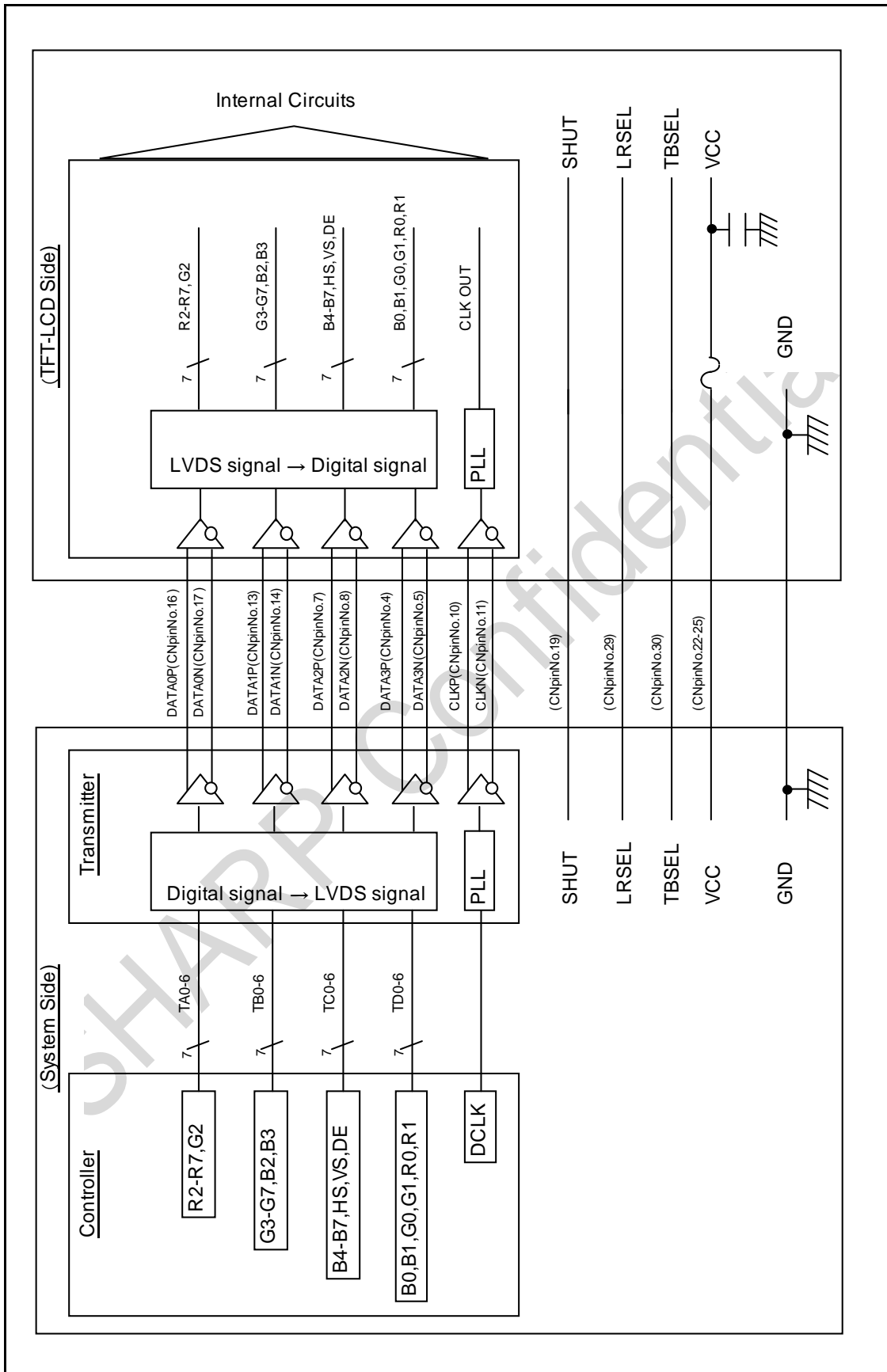

5-3.Data mapping

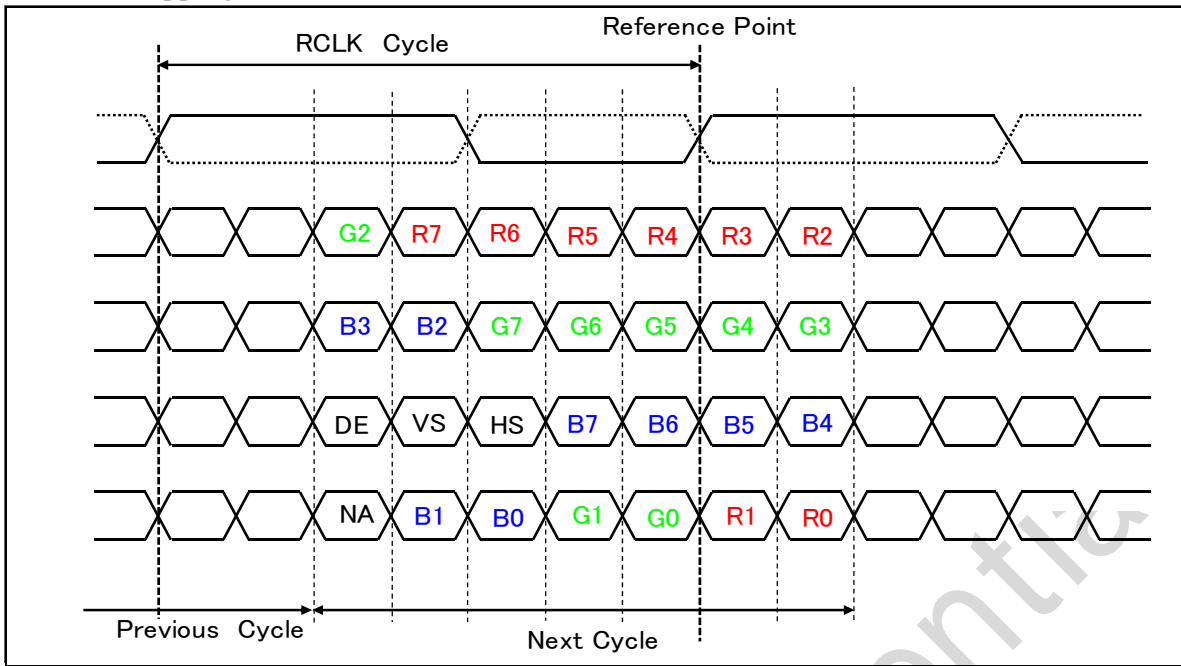

Transmitter		Mapping
Pin No	Data	24bit mode
51	TA0	R2
52	TA1	R3
54	TA2	R4
55	TA3	R5
56	TA4	R6
3	TA5	R7(MSB)
4	TA6	G2
6	TB0	G3
7	TB1	G4
11	TB2	G5
12	TB3	G6
14	TB4	G7(MSB)
15	TB5	B2
19	TB6	B3
20	TC0	B4
22	TC1	B5
23	TC2	B6
24	TC3	B7(MSB)
27	TC4	HS
28	TC5	VS
30	TC6	DE
50	TD0	R0(LSB)
2	TD1	R1
8	TD2	G0(LSB)
10	TD3	G1
16	TD4	B0(LSB)
18	TD5	B1
25	TD6	NA

5-4. Backlight driving

No.	Symbol	function	Remarks
1	GND	GND reference for Pin No.3	
2	GND	GND reference for Pin No.3	
3	TH	Thermistor	
4	N.C.	This is open terminal	
5	VLC3	LED Power supply input 3(-)	Cathode side3
6	VLC2	LED Power supply input 2(-)	Cathode side2
7	VLC1	LED Power supply input 1(-)	Cathode side1
8	N.C.	This is open terminal	
9	VLA1	LED Power supply input (+)	Anode side1
10	VLA2	LED Power supply input (+)	Anode side2

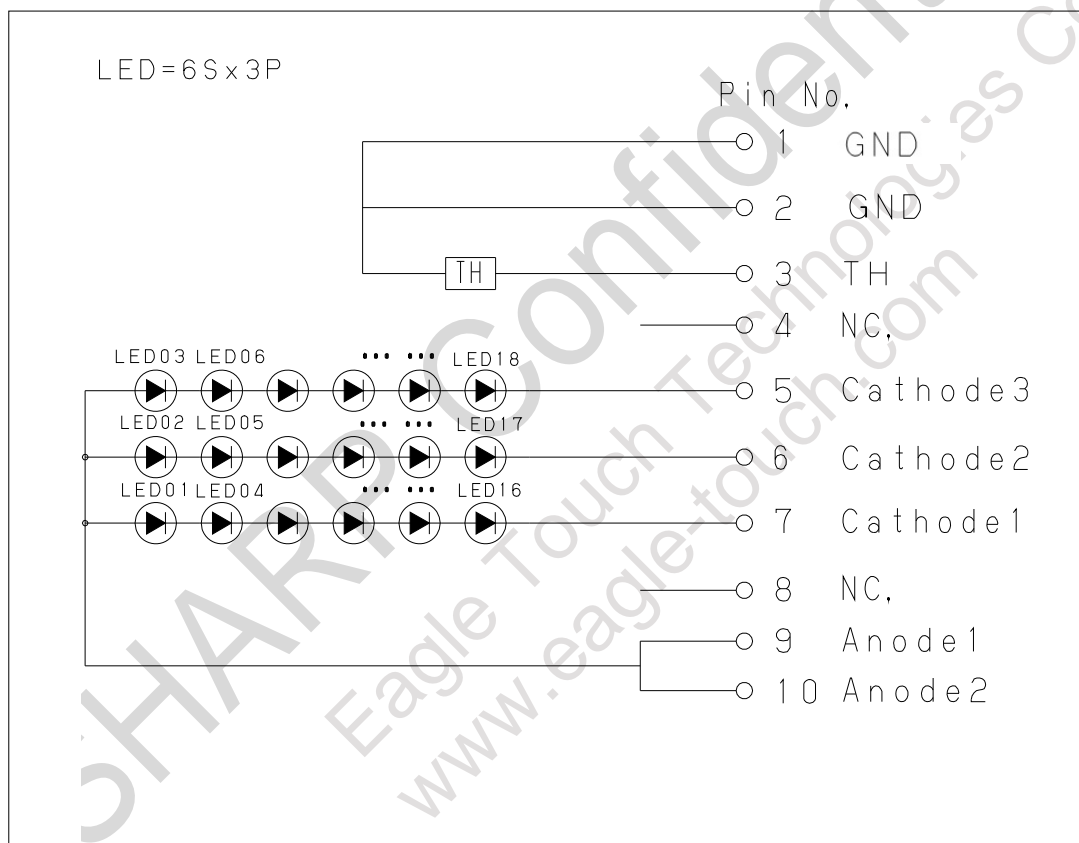

6. Absolute maximum ratings

Absolute maximum ratings of the module are shown in Table 6.

Table 6

GND=0V

1

Item	Symbol	MIN.	MAX.	Unit	Remarks
Power supply Voltage	VCC	0	4.0	V	Ta=25°C
Input Signal Voltage	VID	-0.3	VCC+0.3	V	[Note 6-1] Ta=25°C
Storage Temperature	Tstg	-40	+90	°C	[Note 6-2,3]
Operating Temperature (Panel temperature)	Topr1	-30	+85	°C	[Note 6-2,4,5,6]
Operating Temperature (Ambient temperature)	Topr2	-30	+60	°C	[Note 6-2,5,7]
LED forward current	If	—	100	mA	Ta=25°C

【Note 6-1】 Apply to the terminal DATA0P/N, DATA1P/N, CLKP/N, DATA2P/N, DATA3P/N, SHUT, LRSEL, TBSEL

【Note 6-2】 This rating applies to all parts of the module and should not be exceeded.

【Note 6-3】 Maximum wet-bulb temperature is 57°C. Condensation of dew must be avoided as electrical current leaks will occur, causing a degradation of performance specifications.

【Note 6-4】 The operating temperature is a temperature at which the module is assured to operate. Display quality criteria such as contrast and response speed are evaluated when Ta = 25°C.

【Note 6-5】 Ambient temperature when the backlight is lit at 100% PWM ratio.

【Note 6-6】 Panel temperature is defined as the peak temperature on both the front and rear surfaces of the panel.

【Note 6-7】 LED current must be lower than the line in the figure 6-1.

Dimming shall operate at Ta ≥ TBD °C.

Countermeasures for heat generation from LCD module are required at customer's system.

Fig. 6-1 : Ambient temperature -LED current

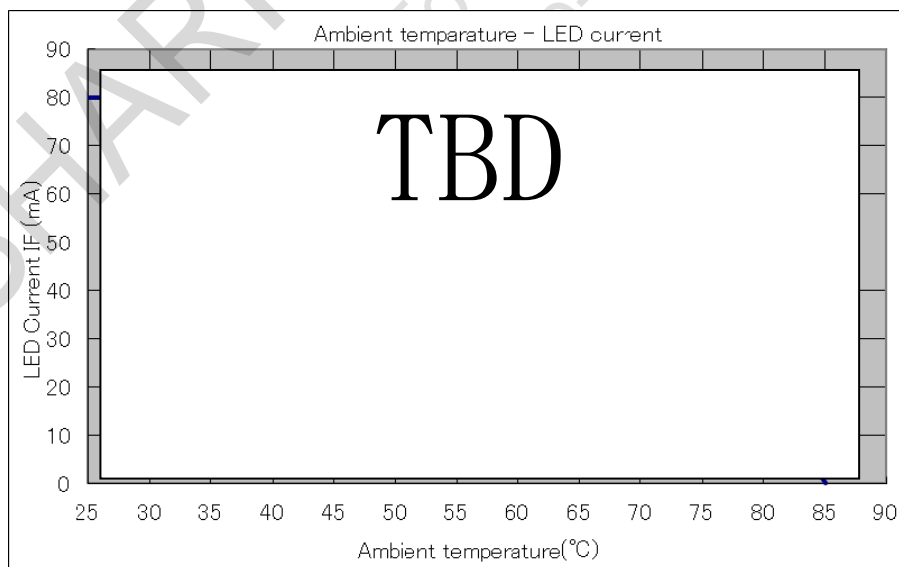

7. Electrical characteristics

7-1.TFT-LCD panel driving

Ta=25°C

Parameter	Condition	Symbol	Min.	Typ.	Max.	Unit	Remark	
Power supply	DC voltage	Vcc	3.0	3.3	3.6	V		
	DC current	VCC=+3.3V	Ivcc	-	95	120	mA	[Note 7-1]
	Rise time		Trise	-	-	10	ms	[Note 7-2]
	Voltage drop		Vth	2.5	-	-	V	[Note 7-2,3]
	Voltage drop time		Tvth	-	-	10	ms	[Note 7-2,3]
	Resupply voltage		Voff	0	-	0.1×VCC	V	[Note 7-3]
	Time of re-power supply		Tpon	700	-	-	ms	[Note 7-3]
Input voltage	Low	VIL	GND	-	0.3×VCC	V	[Note 7-4]	
	High	VIH	0.7×VCC	-	VCC	V		
Differential input threshold voltage	High	VTH	-	-	100	mV	VCM=1.2V	
	Low	VTL	-100	-	-	mV	[Note 7-5]	
Common mode voltage	RT=100Ω	VCM	1.125	1.25	1.375	V	[Note 7-5]	
Input impedance (Differential input)		RT	-	100	-	Ω	[Note 7-5]	
Input current	Low(VI=0V)	IIL	-	-	10.0	uA	[Note 7-4]	
	High(VI=Vcc)	IIH	-10.0	-	-	uA		

△
2

△
2

[Note 7-1]

Display Pattern: White Pattern

Timing: fCLK=33.26MHz , fH=31.75kHz , fV=60Hz

*fH : Frequency of Horizontal synchronous signal (Frequency of HSY) fH=1/tH(t)

*fV : Frequency of Vertical synchronous signal (Frequency of VSY) fV=1/(tH(t)×tV)

[Note 7-2]

Please refer to Fig7-1

Fig. 7-1: VCC waveforms

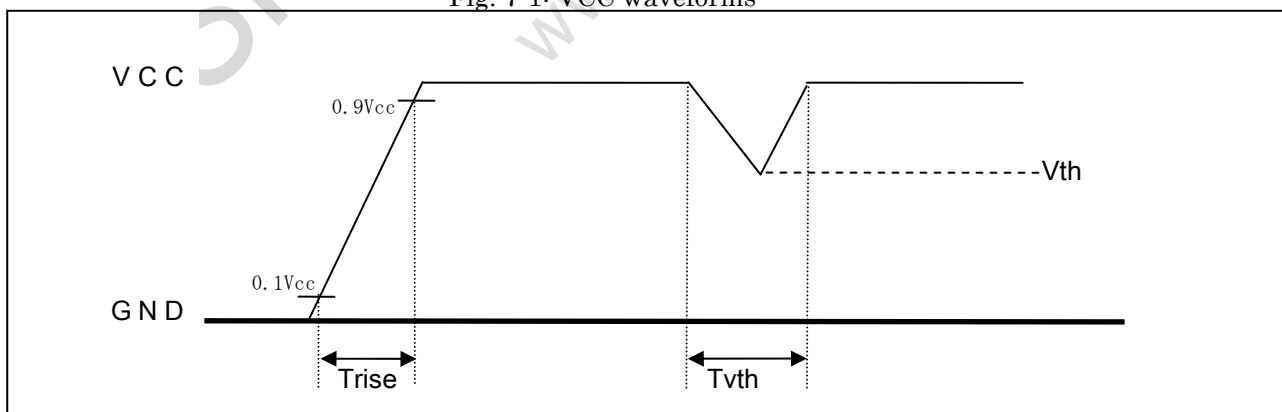

[Note 7-3]

When VCC was less than VTH, re-power supply is necessary. (Please refer to Fig.7-2)

Fig.7-2: Re-power supply sequence

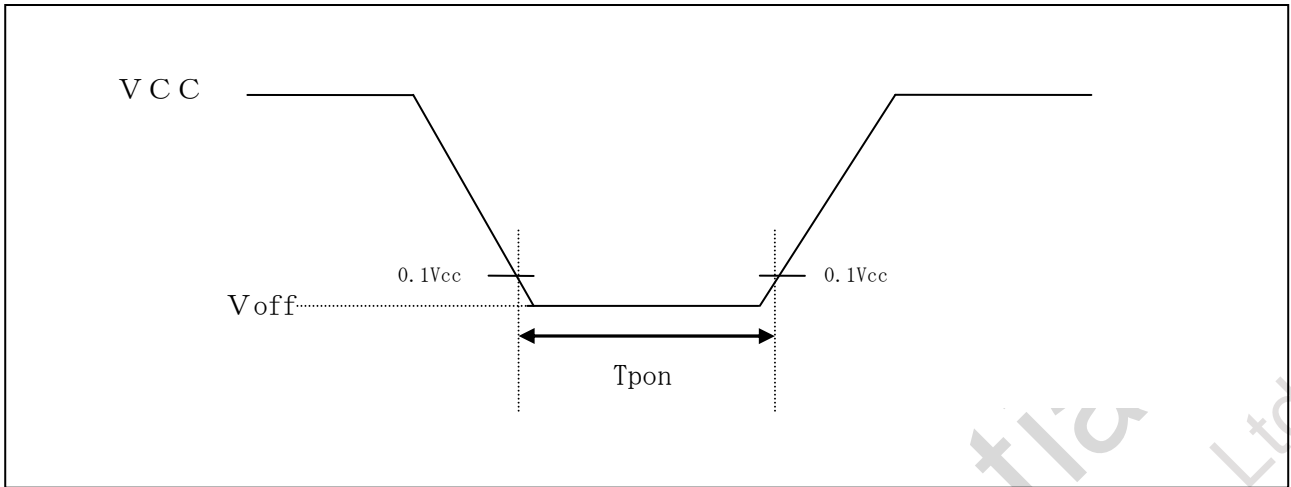

[Note 7-4] SHUT,LRSEL,TBSEL

[Note 7-5] DATAiP/DATAiN(i=0,1,2,3), CLKP/N

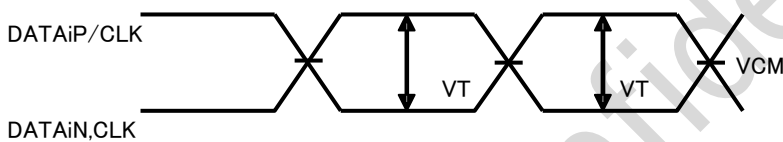

7-2.Power ON sequence

Power ON sequence are shown in Fig7-3, Table 7-1. Please input an input signal after t_1 time in Vcc high level state. Display start is from 9th by counting fall edge of VS.

Fig7-3: Power ON sequence

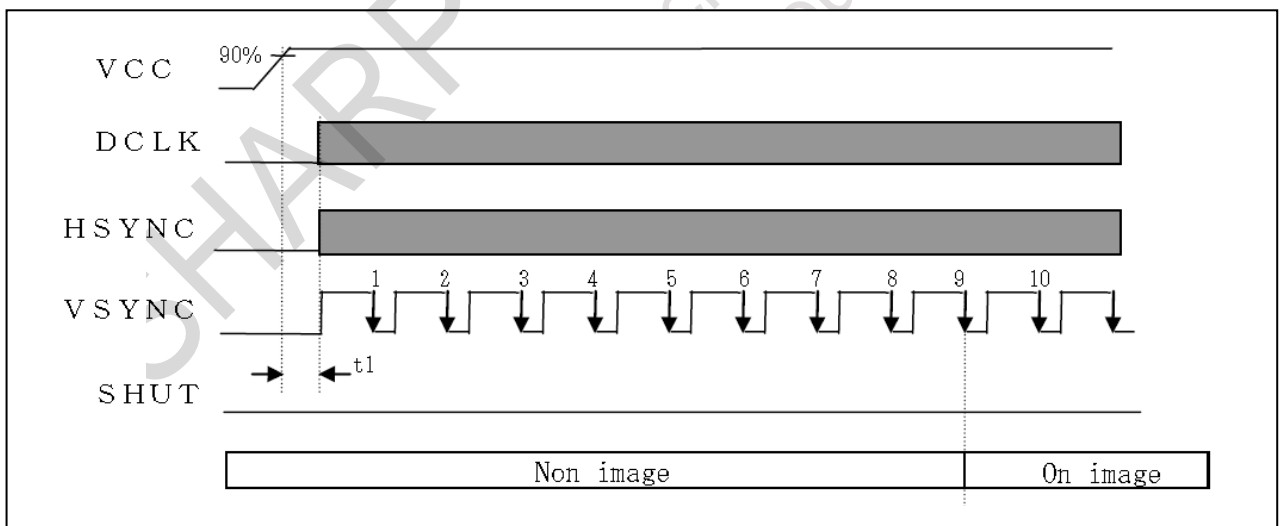

Table 7-1 : Power ON sequence rule

	Symbol	MIN	TYP	MAX	Unit
Time lag of Vcc- input signal	t_1	20	—	—	ms

* Please do not make an SHUT signal high level during a power supply ON sequence (An upper figure " Display OFF period").

7-3. Power OFF sequence

Power OFF sequence are shown in Fig7-4. In a run state usually, power OFF sequences are started by stealing an SHUT signal from a Low level in a High level. Power OFF sequence is carried out for (7th) VS period by first fall edge of VS in the state that SHUT signal became High level.

Fig7-4: Power OFF sequence

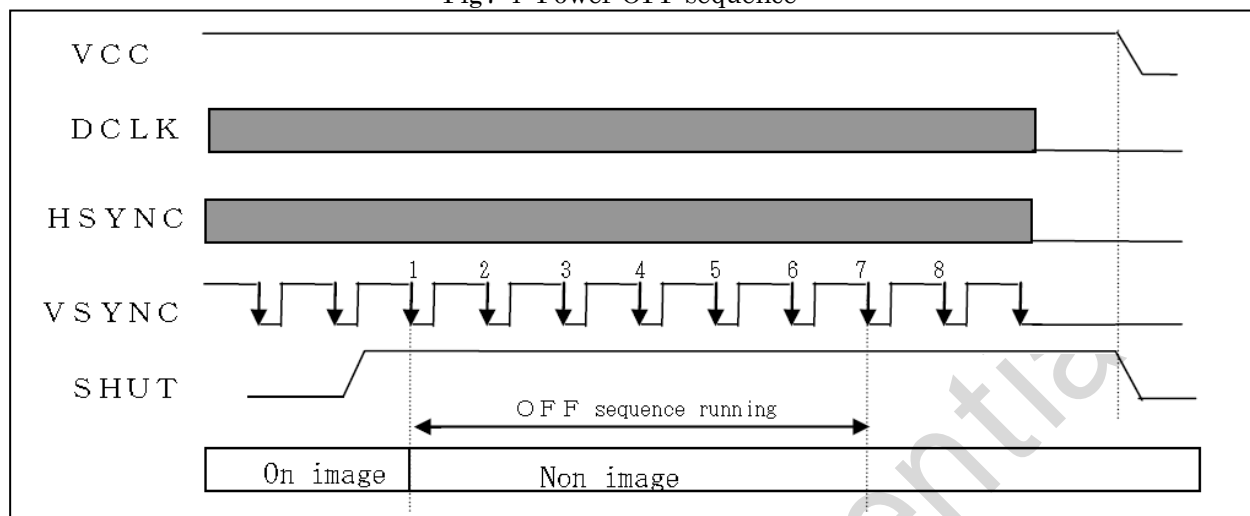

*: Please do not make SHUT a Low level for the "OFF sequence running" period of the upper figure.

*: Please continue inputting an input signal for the "OFF sequence running" period of the upper figure.

*: The supply of RGB Data can be stopped for the "OFF sequence running" period of the upper figure.

7-4. Backlight driving section

Table 7-2 Recommended condition



Ta=25°C

Parameter	Symbol	MIN	TYP	MAX	Unit	Remarks
Input voltage	Vf	(16.2)	(18)	(20.4)	V	Ta =25°C [Note 7-6]
	Vf-30	—	—	(20.94)	V	Ta =-30°C [Note 7-7]
	Vf+85	(15.9)	—	—	—	Ta =85°C [Note 7-7]
Current consumption	If	—	(80)	(90)	mA	one line [Note 7-8]
Power consumption	Wf	—	(4.32)	—	W	[Note 7-9]
PWM Dimming Frequency	fpwm	(150)	—	—	Hz	

[Note 7-6] In this case heat is balanced If=80mA by one line (six series).

[Note 7-7] In this case If=80mA power supply ON by one line (six series).

[Note 7-8] Please use the LED current within Fig 6-1.

[Note 7-9] Wf = Vf×If×parallel qty.

7-5. AC Characteristics (Input LVDS)

Parameter	Symbol	Min	Typ	Max	Unit	Remarks
LVDS clock period	TRCLK	27.4	27.8	33.7	ns	
LVDS Input signal data position bit1	tPOS1	-	0	-	ns	
LVDS Input signal data position bit0	tPOS0	Typ-0.35	(1/7) × Tclk	Typ+0.35	ns	
LVDS Input signal data position bit6	tPOS6	Typ-0.35	(2/7) × Tclk	Typ+0.35	ns	
LVDS Input signal data position bit5	tPOS5	Typ-0.35	(3/7) × Tclk	Typ+0.35	ns	
LVDS Input signal data position bit4	tPOS4	Typ-0.35	(4/7) × Tclk	Typ+0.35	ns	
LVDS Input signal data position bit3	tPOS3	Typ-0.35	(5/7) × Tclk	Typ+0.35	ns	
LVDS Input signal data position bit2	tPOS2	Typ-0.35	(6/7) × Tclk	Typ+0.35	ns	

Fig.7-5 Data input signal timing chart

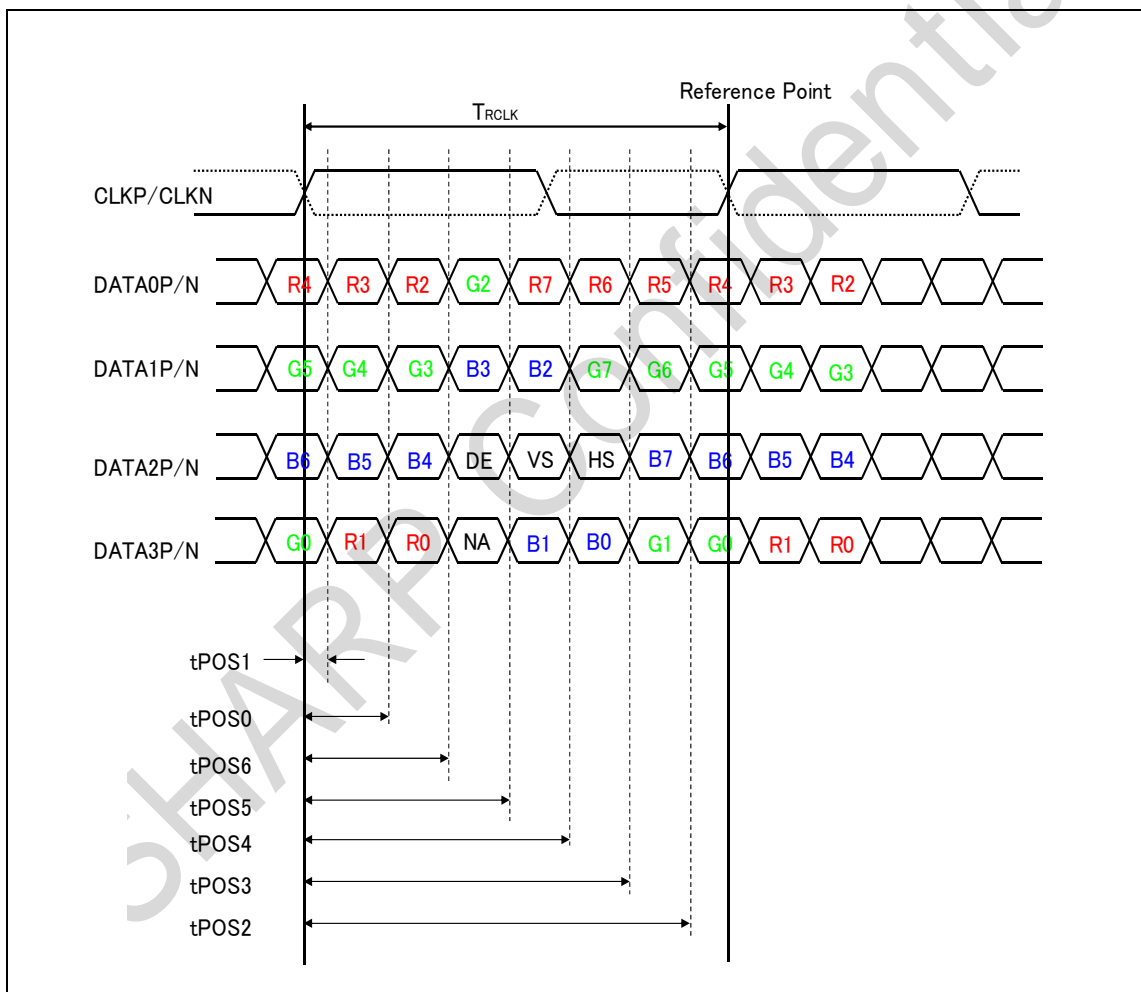

*R7,G7,B7 ⇒ MSB , R0,G0,B0 ⇒ LSB

8 Timing characteristics

Timing diagrams of input signal are shown in Table 8-1, Fig8.

Table 8-1. Input signal timing

VCC=+3.0 ~+3.6V

Parameter	Symbol	MIN	TYP	MAX	Unit	Remarks
DCLK	Frequency	fCLK	31.95	33.26	34.59	MHz
	“High” time	tWCH	8.5	—	—	ns
	“Low” time	tWCL	8	—	—	ns
	Rise time	tCR	—	—	10	ns
	Fall time	tCF	—	—	10	ns
Data	Setup time	tDS	6	—	—	ns
	Hold time	tDH	6	—	—	ns
Horizontal synchronous signal (HS)	Period (time)	tH(t)	31.45	31.75	32.05	us
	Period (clock)	tH(clk)	1024	1056	1088	clk
	Pulse width	tHPW	5	—	tHBP	clk
	Setup time	tHS	6	—	—	ns
	Hold time	tHH	6	—	—	ns
Vertical synchronous signal(VS)	Period	tV	520	525	530	line
	Pulse width	tVPW	2	—	tVBP	line
DE signal	Setup time	tES	6	—	—	ns
	Pulse width	tEPWB	—	tHA	—	clk
Horizontal display period	tHA	—	800	—	clk	
Horizontal Front Porch	tHFP	110	—	—	clk	
Horizontal display Start position(Horizontal Back Porch)	tHBP	20	—	178	clk	Depend on DE signal
HS-VS phase difference	tHV	0	—	1	clk	
Vertical Front Porch	tVFP	5	—	—	line	
Vertical display Start position (Vertical Back Porch)	tVBP	—	31	—	line	
Vertical display period	tVA	—	480	—	line	

Fig8 Timing diagrams of input signal

9. Input Data Signals and Display Position on the screen

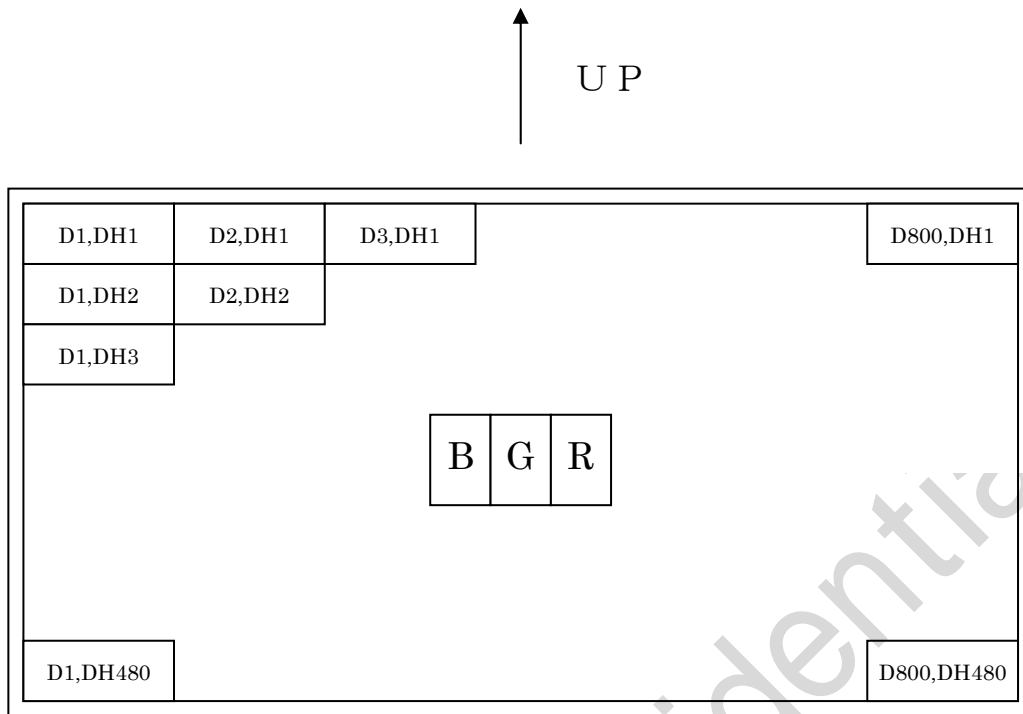

Display position of input data (H,V)

SHARP Confidential
Eagle Touch Technology Co.Ltd
www.eagle-touch.com

10. Input Signals, Basic Display Color and Gray Scale of Each Color

Table10-1

	Colors & Gray scale	Data signal																								
		Gray Scale	R0	R1	R2	R3	R4	R5	R6	R7	G0	G1	G2	G3	G4	G5	G6	G7	B0	B1	B2	B3	B4	B5	B6	B7
Basic color	Black	—	0	0	0	0	0	0	0	0	0	0	0	0	0	0	0	0	0	0	0	0	0	0	0	0
	Blue	—	0	0	0	0	0	0	0	0	0	0	0	0	0	0	0	0	1	1	1	1	1	1	1	1
	Green	—	0	0	0	0	0	0	0	0	1	1	1	1	1	1	1	1	0	0	0	0	0	0	0	0
	Cyan	—	0	0	0	0	0	0	0	0	1	1	1	1	1	1	1	1	1	1	1	1	1	1	1	1
	Red	—	1	1	1	1	1	1	1	1	0	0	0	0	0	0	0	0	0	0	0	0	0	0	0	0
	Magenta	—	1	1	1	1	1	1	1	1	0	0	0	0	0	0	0	0	1	1	1	1	1	1	1	1
	Yellow	—	1	1	1	1	1	1	1	1	1	1	1	1	1	1	1	1	0	0	0	0	0	0	0	0
	White	—	1	1	1	1	1	1	1	1	1	1	1	1	1	1	1	1	1	1	1	1	1	1	1	1
Gray Scale of red	Black	GS0	0	0	0	0	0	0	0	0	0	0	0	0	0	0	0	0	0	0	0	0	0	0	0	0
	↑	GS1	1	0	0	0	0	0	0	0	0	0	0	0	0	0	0	0	0	0	0	0	0	0	0	0
	Darker	GS2	0	1	0	0	0	0	0	0	0	0	0	0	0	0	0	0	0	0	0	0	0	0	0	0
	↑	↓					↓							↓								↓				
	↓	↓					↓							↓								↓				
	Brighter	GS253	1	0	1	1	1	1	1	1	0	0	0	0	0	0	0	0	0	0	0	0	0	0	0	0
	↓	GS254	0	1	1	1	1	1	1	1	0	0	0	0	0	0	0	0	0	0	0	0	0	0	0	0
	Red	GS255	1	1	1	1	1	1	1	1	0	0	0	0	0	0	0	0	0	0	0	0	0	0	0	0
Gray Scale of green	Black	GS0	0	0	0	0	0	0	0	0	0	0	0	0	0	0	0	0	0	0	0	0	0	0	0	0
	↑	GS1	0	0	0	0	0	0	0	0	1	0	0	0	0	0	0	0	0	0	0	0	0	0	0	0
	Darker	GS2	0	0	0	0	0	0	0	0	0	1	0	0	0	0	0	0	0	0	0	0	0	0	0	0
	↑	↓					↓							↓								↓				
	↓	↓					↓							↓								↓				
	Brighter	GS253	0	0	0	0	0	0	0	0	1	0	1	1	1	1	1	1	0	0	0	0	0	0	0	0
	↓	GS254	0	0	0	0	0	0	0	0	0	1	1	1	1	1	1	1	0	0	0	0	0	0	0	0
	Green	GS255	0	0	0	0	0	0	0	0	1	1	1	1	1	1	1	1	0	0	0	0	0	0	0	0
Gray Scale of blue	Black	GS0	0	0	0	0	0	0	0	0	0	0	0	0	0	0	0	0	0	0	0	0	0	0	0	0
	↑	GS1	0	0	0	0	0	0	0	0	0	0	0	0	0	0	0	0	1	0	0	0	0	0	0	0
	Darker	GS2	0	0	0	0	0	0	0	0	0	0	0	0	0	0	0	0	0	1	0	0	0	0	0	0
	↑	↓					↓							↓								↓				
	↓	↓					↓							↓								↓				
	Brighter	GS253	0	0	0	0	0	0	0	0	0	0	0	0	0	0	0	0	1	0	1	1	1	1	1	1
	↓	GS254	0	0	0	0	0	0	0	0	0	0	0	0	0	0	0	0	0	1	1	1	1	1	1	1
	Blue	GS255	0	0	0	0	0	0	0	0	0	0	0	0	0	0	0	0	1	1	1	1	1	1	1	1

0 : Low level voltage 1 : High level voltage

Each basic color can be displayed in 255 gray scales from 8 bit data signals. According to the combination of total 24 bit data signals, the 16,777,216-color display can be achieved on the screen.

11. Optical characteristics

Table 11-1



Ta= +25°C

Parameter	Symbol	Condition	MIN	TYP	MAX	Unit	Remarks	
Viewing angle range	θ_{21}, θ_{22} θ_{11}, θ_{12}	$10 \leq CR$	70	80		°(degree)	[Note 11-1,2]	
Contrast ratio	CRmax	Perpendicular	—	1800	—		[Note 11-2]	
Response time	+25°C $\tau_r + \tau_d$	$\theta = 0^\circ$	—	—	40	ms	[Note 11-3]	
Luminance	Y	If=80mA	—	650	—	cd/m ²	[Note 11-4]	
Chromaticity	White	If=80mA	(0.240)	(0.290)	(0.340)		[Note 11-4,6]	
			(0.270)	(0.320)	(0.370)			
Luminance uniformity	Lmin / Lmax	$\theta = 0^\circ$ 9point	70			%	[Note 11-7]	
LED life	+25°C	—	continuation	10000	—	—	hour	[Note 11-5]

*Measuring after 30minutes operation. The measurement of the optical character is measured by using the method of fig.11-1 under the condition which is equal to the darkroom or the darkroom.

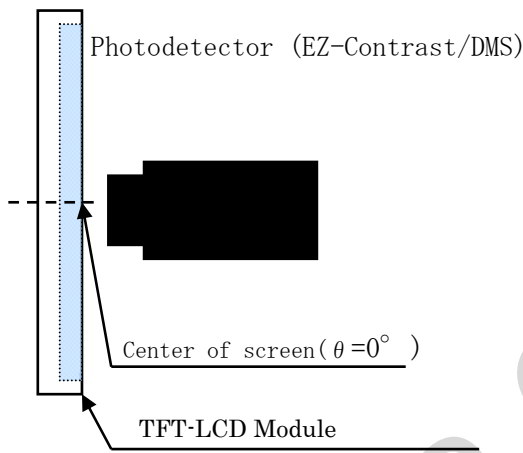

Fig11-1 Viewing angle / Range measurement method

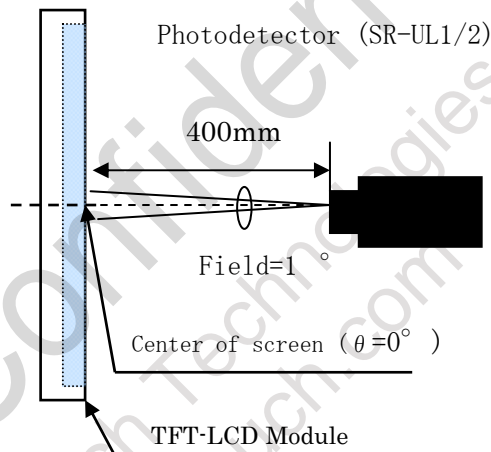
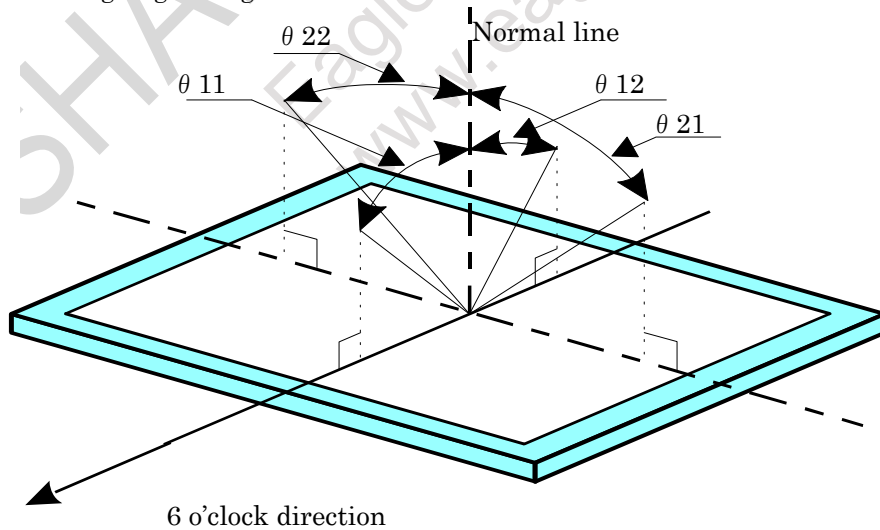

Fig11-2 Luminance / Chromaticity / Contrast measurement method

【Note 11-1】 Viewing angle range is defined as follows.



【Note 11-2】 Contrast ratio of transmission is defined as follows:

$$\text{Contrast ratio(CR)} = \frac{\text{Photo detector output with LCD being "white"(GS255)}}{\text{Photo detector output with LCD being "black"(GS0)}}$$

【Note 11-3】 Response time is obtained by measuring the transition time of photo detector output, when input signals are applied so as to make the area "black" to and from "white".

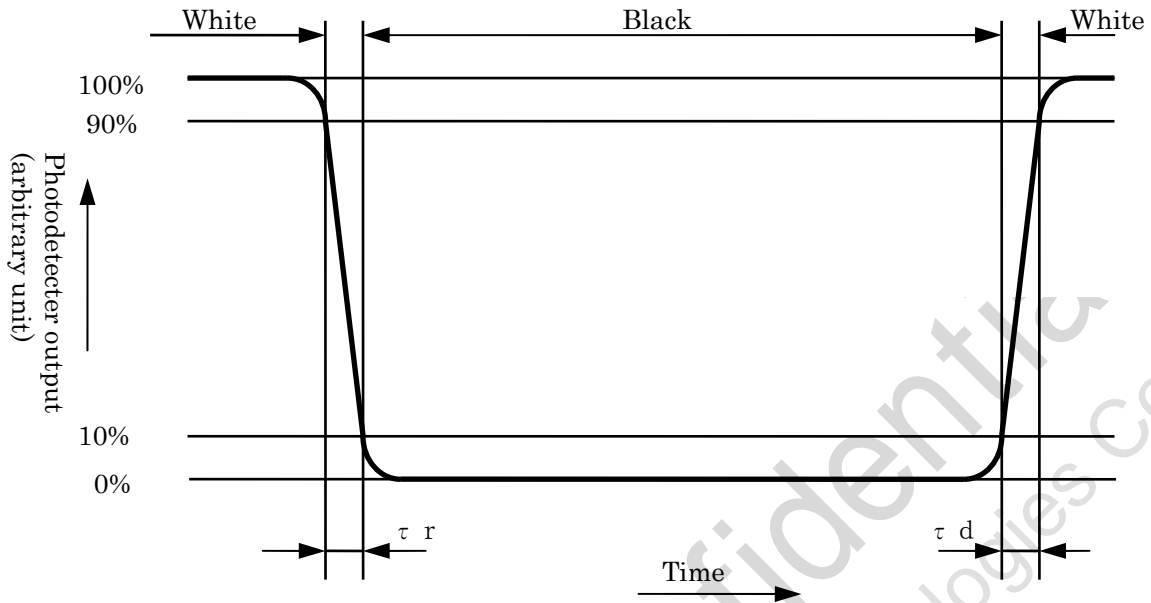

【Note 11-4】 Measured on the center area of the panel at a viewing cone 1° by TOPCON luminance meter SR-UL1/2.(After 30 minutes operation/ If=80mA)

【Note 11-5】 LED life time is defined as the time when the brightness of the panel not to become less than 50% of the original value in the continuous operation under the condition of LED current If=80mA and PWM dimming 100%~5% .

【Note 11-6】 The final typical value for W will be determined after sample evaluation.

The tolerance will be ±0.05 from typical value.

【Note 11-7】 Luminance uniformity is defined as follows

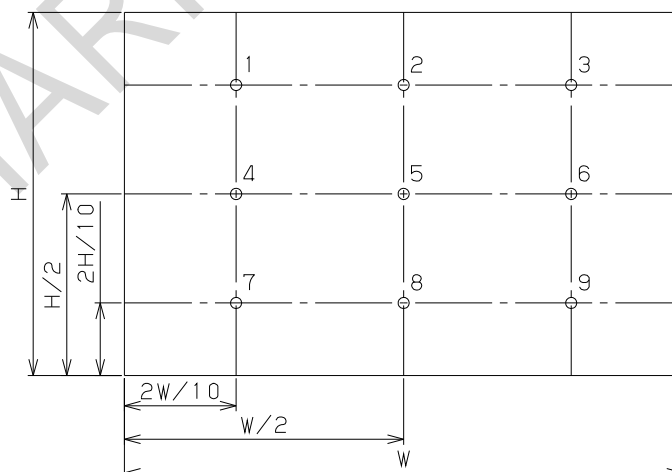

The measurement of Luminance measures nine points of the above figure.

The maximum and minimum luminance is chosen as a result.

$$\text{Luminance uniformity} = \text{Minimum Luminance} / \text{Maximum Luminance} (\%)$$

12. Display quality

The display quality of the color TFT-LCD module is applied to the Incoming Inspection Standard.

13. Mechanical characteristics

13-1.External appearance

No extreme defect exists.

13-2.Panel: Surface Compression Strength

Panel Fracture: The panel must not break at 19N pressure on the center applied by a smooth surface of 15mm diameter.

(Note) No matter how little its weight is, it may interfere with the function if any pressure is applied for a long time on the viewing area.

13-3.Input connector performance:

A) FPC for TFT panel driving parts

(1) Applied Connector: FH52-32S-0.5SH (05) [HIROSE]

14. Handling instructions

14-1.Handling of LED-FPC

- ① Please do not hang a LCD module or do not apply excessive power for LED-FPC.
- ② Please do not fold the LED-FPC. Please follow Sharp's FPC handling recommendations for bending the LED-FPC and under all circumstances ensure the minimum bend radius guideline of 0.5mm is observed.

14-2. Precautions in mounting

Polarizer which is made of soft material and susceptible to flaw must be handled carefully. Protective sheet is applied on the surface to protect it against scratches and dirties. It is recommended to peel off the protective sheet immediately before the use, taking care of static electricity Precautions in peeling off protective sheet.

A) Working environment

When the protective sheet is peeled off, static electricity may cause dust to stick to the polarizer surface.

To avoid this, the following working environment is desirable.

- a) Floor: Conductive treatment of 1MΩ or more on the tile.
(conductive mat or conductive paint on the tile)
- b) Clean room free from dust and with an adhesive mat on the doorway.
- c) Advisable humidity:50%~70% Advisable temperature:15°C~27°C
- d) Workers shall wear conductive shoes, conductive work clothes, conductive gloves and an earth band.

B) Working procedures

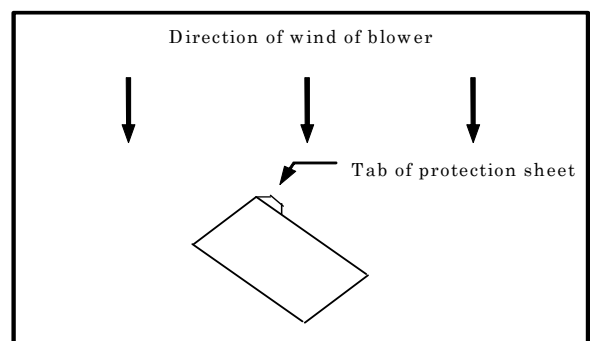
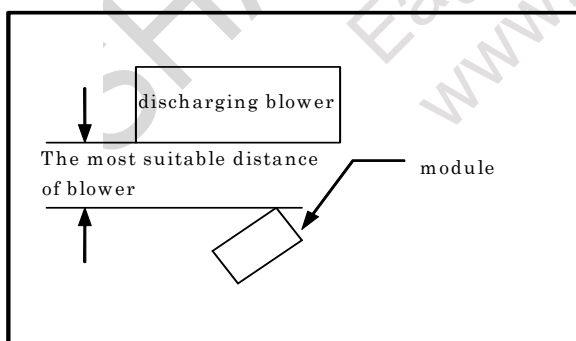

- a) Direct the wind of discharging blower somewhat downward to ensure that module is blown sufficiently.
Please set the distance between module and discharging blower the most suitable distance of blower.

- b) Peel off protective sheet, pulling tab of protection sheet slowly to your side taking 5 or more second.
- c) On peeling off the protective sheet, pass the module to the next work process to prevent the module to get dust.
- d) Method of removing dust from polarizer
 - Blow off dust with N2 blower for which static electricity preventive measure has been taken.
 - Since polarizer is vulnerable, wiping should be avoided.
But when the panel has stain or grease, we recommend to use adhesive tape to softly remove them from the panel.

When metal part of the TFT-LCD module (shielding case and rear case) is soiled, wipe it with soft dry cloth. For stubborn dirties, wipe the part, breathing on it.

Wipe off water drop or finger grease immediately. Long contact with water may cause discoloration or spots.

TFT-LCD module uses glass which breaks or cracks easily if dropped or bumped on hard surface. Handle with care. Since LSI is used in this module, take care of static electricity and earth your body when handling.

14-3. Caution of product design

Please following items strictly when the product is designed by using this module.

- The LCD module shall be protected against water salt-water by the waterproof cover..
- Please take measures to ensure electromagnetic radiation from module does not cause interfere to operation of surrounding appliances.
- Although it has reduction structure about the optical leak from the inside of a module, all parts of LCD module cannot be protected. Please check that this leakage doesn't affect your system in customer side.
- About the FPC/FFC design of the LCD panel drive input part, please refer to recommended FPC/FFC dimensions of input connector which FH52-32S-0.5SH (05) [HIROSE]. In addition, The terminal of FFC/FPC recommend gold or gold plating specification. Because point of contact with input connector is gold plating specification.
- Attachment of input/output FPC and removal should surely turn off the power supply of a set.
- An implementation part crops out on the back of the LCD module. Please carry out insulation measures not to come in contact with the conductive member/electronic parts of your company set at the time of the set design.
- In order to prevent light leakage ,please consider the design of your company set.
- In order to ensure fully grounding, please design two corresponding pins contacted with the two GND on the PWB of the module on your company set. (See Fig.1)
- This product is generating various power supplies required for a liquid crystal display inside a product, and is a power supply start-up, Synchronizing with the inside voltage generation of a liquid crystal display, rushes current occurs in VCC.
Since a voltage drop occurs depending on the output impedance of the VCC power supply of a set, it is less than the threshold value (Typ:2.4V/Max:2.5V) of reset IC carried in this product, and the fault of not starting normally may occur. Please fully inquire in the case of a products design. Moreover, since the fuse is not mounted in the VCC power supply line of this product, please consider a fail-safe power supply design so that you may not go into over-current mode.
- When carrying out PWM Dimming, a display noise may occur depending on Dimming frequency. Please fully inquire in the case of a products design.

Recommendation Dimming frequency :

frequency multiplying of Frame rate or high-frequency(over 1kHz)

14-4. Others

- ① Do not expose the module to direct sunlight or intensive ultraviolet rays for several hours; liquid crystal is deteriorated by ultraviolet rays.
- ② Store the module at a temperature near the room temperature. At lower than the rated storage temperature, liquid crystal solidifies, causing the panel to be damaged. At higher than the rated storage temperature, liquid crystal turns into isotropic liquid and may not recover.
- ③ If LCD panel breaks, there may be a possibility that the liquid crystal escapes from the panel. Since the liquid crystal is injurious, do not put it into the eyes or mouth. When liquid crystal sticks to hands, feet or clothes, wash it out immediately with soap.
- ④ Observe all other precautionary requirements in handling general electronic components.
- ⑤ When handling LCD modules and assembling them into cabinets, please avoid that long-terms storage in the environment of oxidization or deoxidization gas and the use of such materials as reagent, solvent, adhesive, resin, etc. which generate these gasses, may cause corrosion and discoloration of the modules. Do not use the LCD module under such environment.



15. Packing form

- a) Piling number of cartons : MAX 8
- b) Package quantity in one carton 28 pcs
- c) Carton size: 624*419*247
- d) Total mass of one carton filled with full modules: 14.1kg (MAX)
- e) Recommended warehouse storage conditions
 - Environment
 - ①Temperature : 0~40°C
 - ②Humidity : 60%RH or less (at 40°C)
No dew condensation at low temperature and high humidity.
 - ③Atmosphere :Harmful gas, such as acid or alkali which corrodes electronic components and/or wires, must not be detected.
 - ④Period : about 3 months
 - ⑤Opening of the package : In order to prevent the LCD module from breakdown by electrostatic charges, please control the room humidity over 50%RH and open the package taking sufficient countermeasures against electrostatic charges, such as earth, etc.



16. Indication of lot number

- ① Attached location of the label: See Fig.1(Outline Dimensions)
- ② Indicated contents of the label

LQ080Y3LW01 __ 4X000001 _
 ① ②③④⑤ ⑥ ⑦

- ① Model name
- ② blank
- ③ blank
- ④ production year (ex. 2014 ⇒ 4)
- ⑤ production month 1,2,3,·····,9,X(Oct.),Y(Nov.),Z(Dec.)
- ⑥ serial number (000001~)
- ⑦ Revision number Blank,A,B,C···

17.Others

17-1. Factory locations

LCD Panel production : SHARP CORPORATION (Japan Mie)

LCM ssembly : WSEC(China Wuxi)

17-2.About RoHS

This TFT-LCD module corresponds to the RoHS.

17-3.Disposal of module

I'd like a process of in accordance with laws and regulations when it is disposed of by any chance, this TFT-LCD module.

SHARP Confidential
Eagle Touch Technologies Co.Ltd
www.eagle-touch.com

18. Reliability test condition

Table 18-1 Reliability test

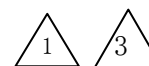

No.	Test items	Test condition
1	High temperature storage test	Ta = +90°C 240h
2	Low temperature storage test	Ta = -40°C 240h
3	High temperature and high humidity operation test	Tp = +60°C, 90%RH 240h
4	Hi temperature operating test	Tp = +85°C 240h
5	Low temperature operating test	Ta = -30°C 240h
6	Electro static discharge test	±200V · 200pF(0Ω) 1 time for each terminals
7	Shock test	980m/s ² · 6ms, ±X ; ±Y ; ±Z 3 times for each direction
8	Vibration test	Frequency : 8~33.3Hz , Stroke : 1.3mm Frequency : 33.3Hz~400Hz,Acceleration : 29.4m/s ² Cycle : 15 minutes X,Z 2 hours for each directions, 4 hours for Y direction (total 8 hours)
9	Heat shock test	-30°C ~ +85°C , 200 cycles (0.5h) (0.5h)

Ta = Ambient temperature, Tp = Panel temperature

【Check items】

In the standard condition, there shall be no practical problems that may affect the display function.

【Note】

Definition of X, Y, Z direction is shown as follows

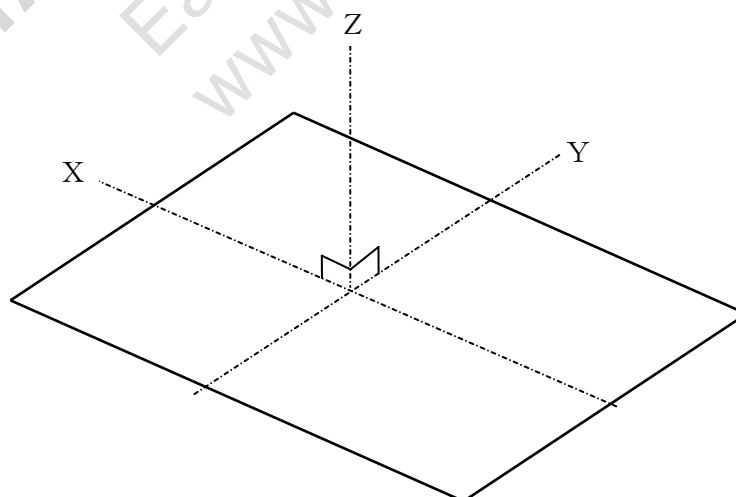

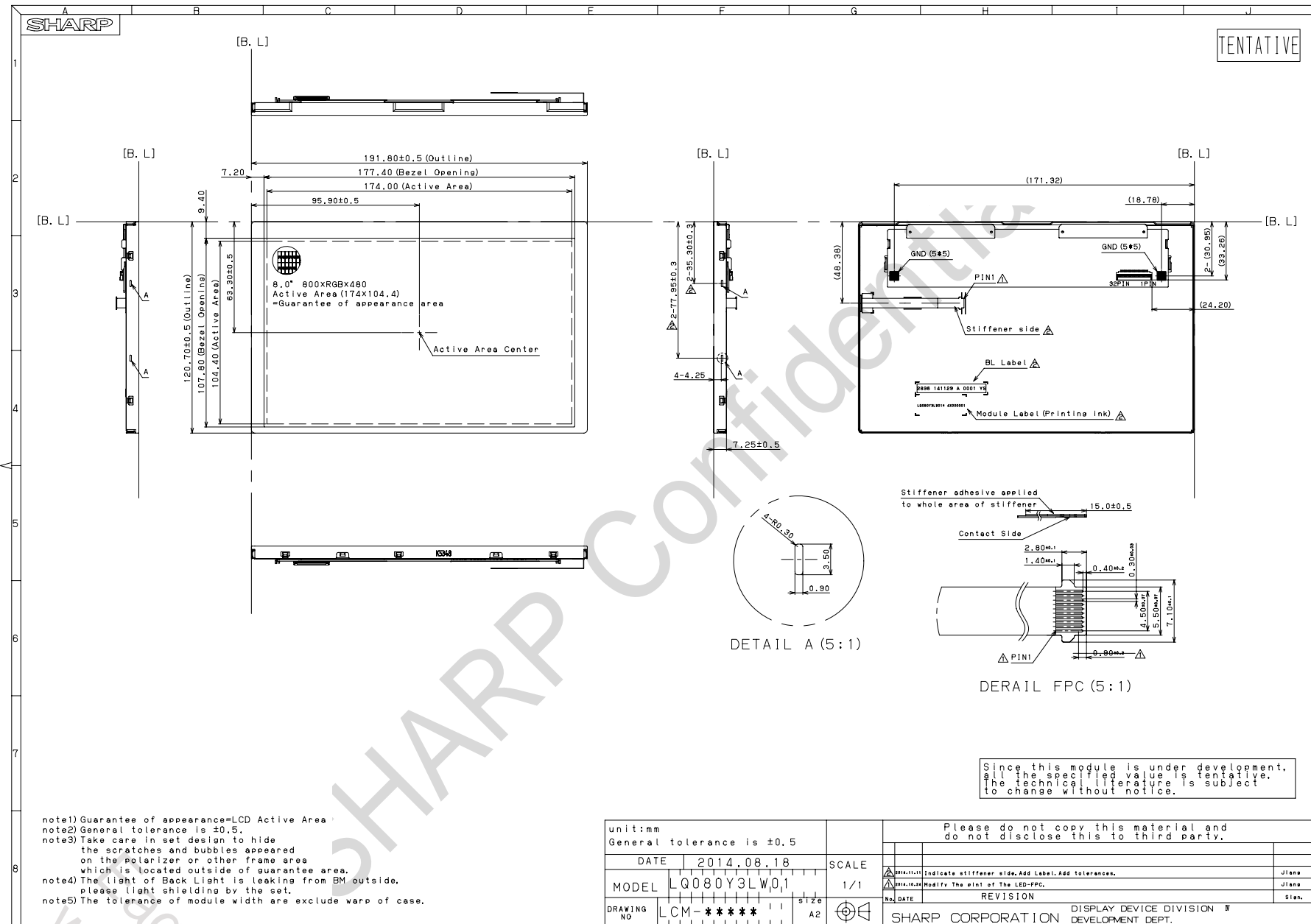

Fig1.Outline Dimensions ① ②

2 20. Packing form

